

# Ausgeführte Objekte

Wärmegeämmte Fassadensysteme

# Objets réalisés

Systèmes de façades à rupture de pont thermique

# Completed projects

Thermally insulated façade systems





3 Wissenschafts-  
zentrum Kopernikus,  
Warschau/PL



4 Schloss Novy Svetlov,  
Bojkovice/CZ



5 Hotel Magyar Király,  
Székesfehérvár/HU



6 Theater- und  
Konzerthaus Kilden,  
Kristiansand/NO



8 Museum für  
moderne Kunst,  
Zagreb/HR



10 Museum für Kunst  
und Kulturgeschichte  
Altona,  
Hamburg-Altona/DE



11 TransPort  
(Flughafen Schiphol),  
Amsterdam/NL



12 Büro- und  
Geschäftshaus  
«Hillsite»,  
Schwalbach am  
Taunus/DE



14 Zentralarchiv EDF,  
Bure/FR



16 Gemeindehaus,  
Ruidellots de la  
Selva/ES



17 Hauptbahnhof,  
Köln/DE



18 Universität  
Lausanne  
«Géopolis»,  
Lausanne/CH



20 Jansen AG, Campus,  
Oberriet/CH



22 Bildungsforum,  
Potsdam/DE



24 Besucherzentrum  
«Alte Wasserzentrale»,  
Pietra Neamt/RO



26 Hotel Novi Spa,  
Novi Vinodolski/HR



27 Solvias AG, Büro-  
und Lagergebäude,  
Kaiseraugst/CH



28 Médiathèque,  
Pau/FR



30 «Mumuth» Haus  
für Musik &  
Musiktheater der  
Kunstuniversität,  
Graz/AT



32 Centre Pompidou,  
Metz/FR



33 Alters- und  
Pflegeheim,  
Burgdorf/CH



34 Drents Museum,  
Assen/NL



36 Akustik-Tunnels,  
Warschau/PL



38 Jin Ji Hu  
Kempinski Hotel,  
Suzhou/CN

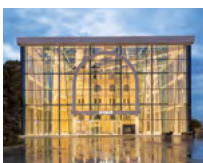

39 Historisches  
Museum,  
Kharkov/UA



40 Kunstgebäude,  
Stuttgart/DE



42 3-Feldsporthalle,  
Ingelfingen/DE



44 Musikkonservatorium,  
Bilbao/ES



45 Landesberufsschule,  
Mureck/AT



46 Hafencity Schule,  
Hamburg/DE



48 Drehrestaurant  
«Hoher Kasten»,  
Brülisau/CH



50 Hauptbahnhof  
«Rotterdam Centraal»,  
Rotterdam/NL



52 IGuzzini  
Illuminazione,  
Barcelona/ES



54 «Erasmus»  
Studenten-Pavillon,  
Rotterdam/NL



56 Hochschule  
«Anstalt für  
angewandte  
Wissenschaften»,  
Dessau/DE



57 Justizgebäude,  
Würzburg/DE



58 Halle M, Jansen AG,  
Oberriet/CH



60 Vogtlandhalle  
(Stadthalle),  
Greiz/DE



62 Ausbau Messehalle  
BEA Expo,  
Bern/CH



63 MAN Nutzfahrzeuge,  
Werkserweiterung,  
München/DE



64 Museumsquartier,  
Den Bosch/NL



66 Werkhalle  
Glas Trösch,  
St.Gallen/CH



67 Voentorg Center,  
Moskau/R



68 Neue Messehalle  
(Kielce Trade Fairs),  
Kielce/PL

# Ausgeführte Objekte Objets réalisés Completed projects

**JANSEN**

**Objekt:**

Wissenschaftszentrum Kopernikus,  
Centrum Nauki Kopernik, Warschau/PL

**System:**

VISS TVS, VISS SG, VISS Fire,  
Janisol 2 EI30, Janisol SG

**Architekt:**

RAR-2 Laboratorium Architektury  
Jan Kubec, Ruda Śląska/PL

**Objet:**

Centre de recherche Copernique,  
Centrum Nauki Kopernik, Varsovie/PL

**Système:**

VISS TVS, VISS SG, VISS Fire,  
Janisol 2 EI30, Janisol SG

**Architecte:**

RAR-2 Laboratorium Architektury  
Jan Kubec, Ruda Śląska/PL

**Project:**

Copernicus Science Centre,  
Centrum Nauki Kopernik, Warsaw/PL

**System:**

VISS TVS, VISS SG, VISS Fire,  
Janisol 2 EI30, Janisol SG

**Architect:**

RAR-2 Laboratorium Architektury  
Jan Kubec, Ruda Śląska/PL



Ausgeführte Objekte  
Objets réalisés  
Completed projects



**Objekt:**

Schloss Novy Svetlov, Bojkovice/CZ

**System:**

VISS SG, VISS TVS (schräg)

**Architekt:**

Stavos s.r.o., Příbram/CZ

**Objet:**

Château Novy Svetlov, Bojkovice/CZ

**Système:**

VISS SG, VISS TVS (oblique)

**Architecte:**

Stavos s.r.o., Příbram/CZ

**Project:**

Novy Svetlov castle, Bojkovice/CZ

**System:**

VISS SG, VISS TVS (sloping)

**Architect:**

Stavos s.r.o., Příbram/CZ

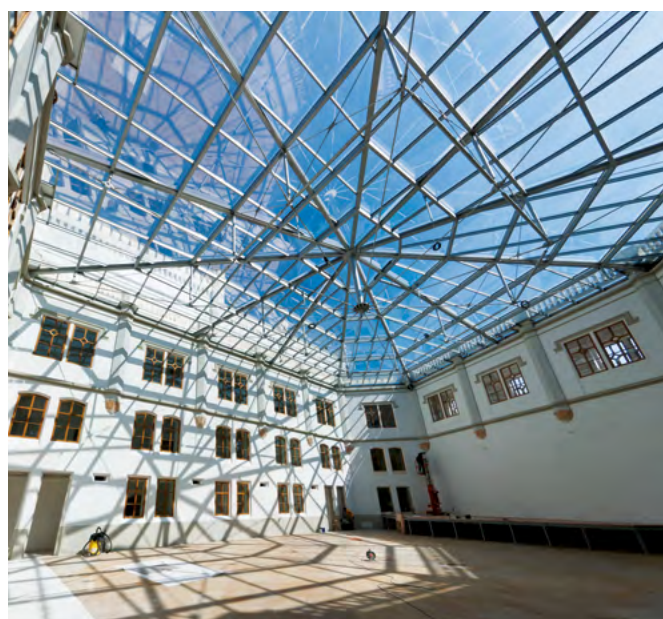

**Objekt:**

Hotel Magyar Király,  
Székesfehérvár/HU

**System:**

VISS TVS (schräg)

**Architekt:**

Szendro Epitesz Studio, Budapest/HU

**Objet:**

Hôtel Magyar Király,  
Székesfehérvár/HU

**Système:**

VISS TVS (oblique)

**Architecte:**

Szendro Epitesz Studio, Budapest/HU

**Project:**

Hotel Magyar Király, Székesfehérvár/  
HU

**System:**

VISS TVS (sloping)

**Architect:**

Szendro Epitesz Studio, Budapest/HU

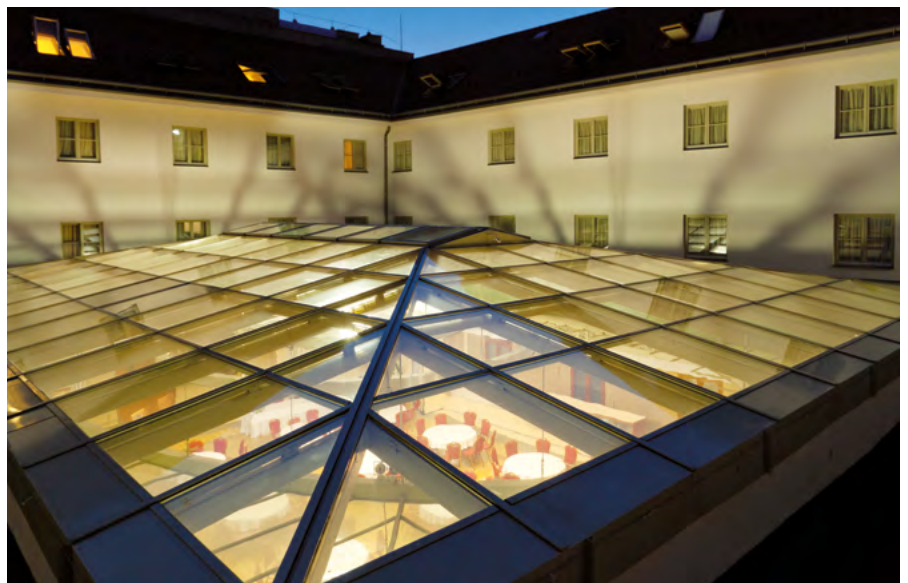

# Ausgeführte Objekte

## Objets réalisés

### Completed projects

**Objekt:**

Theater- und Konzerthaus Kilden,  
Kristiansand/NO

**System:**

VISS I<sub>x</sub>tra

**Architekt:**

ALA Architects, Helsinki/SF

**Objet:**

Maison du théâtre et des concerts  
Kilden, Kristiansand/NO

**Système:**

VISS I<sub>x</sub>tra

**Architecte:**

ALA Architects, Helsinki/SF

**Project:**

Kilden Performing Arts Centre,  
Kristiansand/NO

**System:**

VISS I<sub>x</sub>tra

**Architect:**

ALA Architects, Helsinki/SF



Fotos: Jiri Havran, Oslo



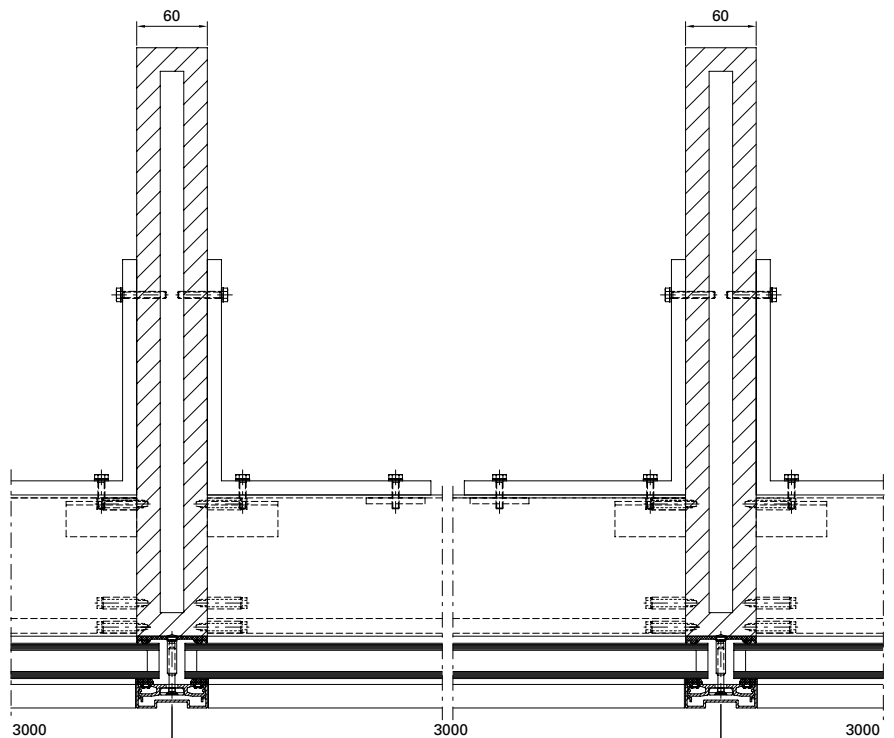
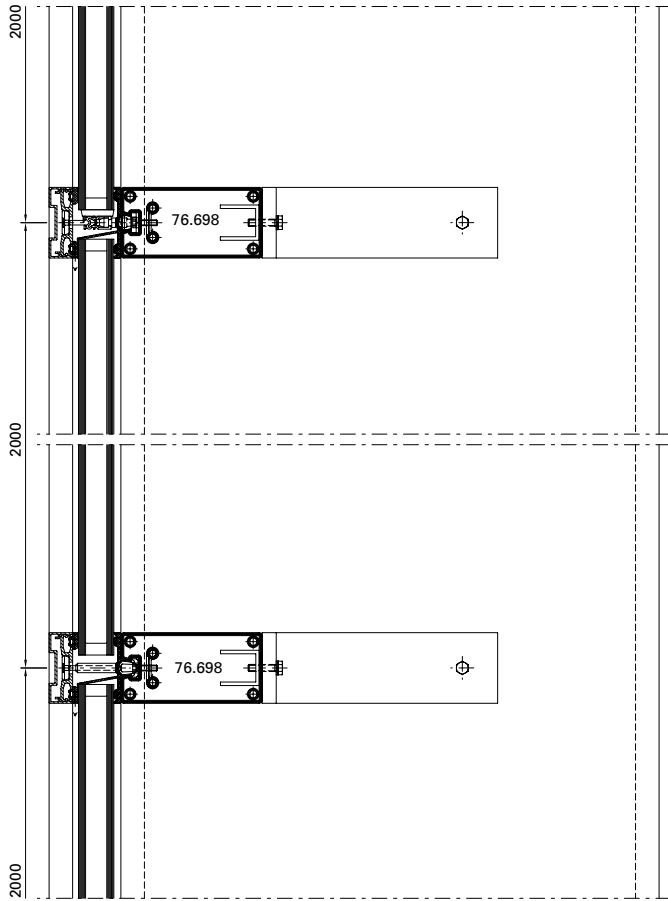

# Ausgeführte Objekte

## Objets réalisés

### Completed projects

**Objekt:**

Museum für moderne Kunst, Zagreb/  
HR

**System:**

VISS SG

**Architekt:**

Igor Franić Architekturstudio SZA,  
Zagreb/HR

**Objet:**

Musée de l'art contemporain,  
Zagreb/HR

**Système:**

VISS SG

**Architecte:**

Igor Franić Architekturstudio SZA,  
Zagreb/HR

**Project:**

Museum of Contemporary Art, Zagreb/  
HR

**System:**

VISS SG

**Architect:**

Igor Franić Architekturstudio SZA,  
Zagreb/HR

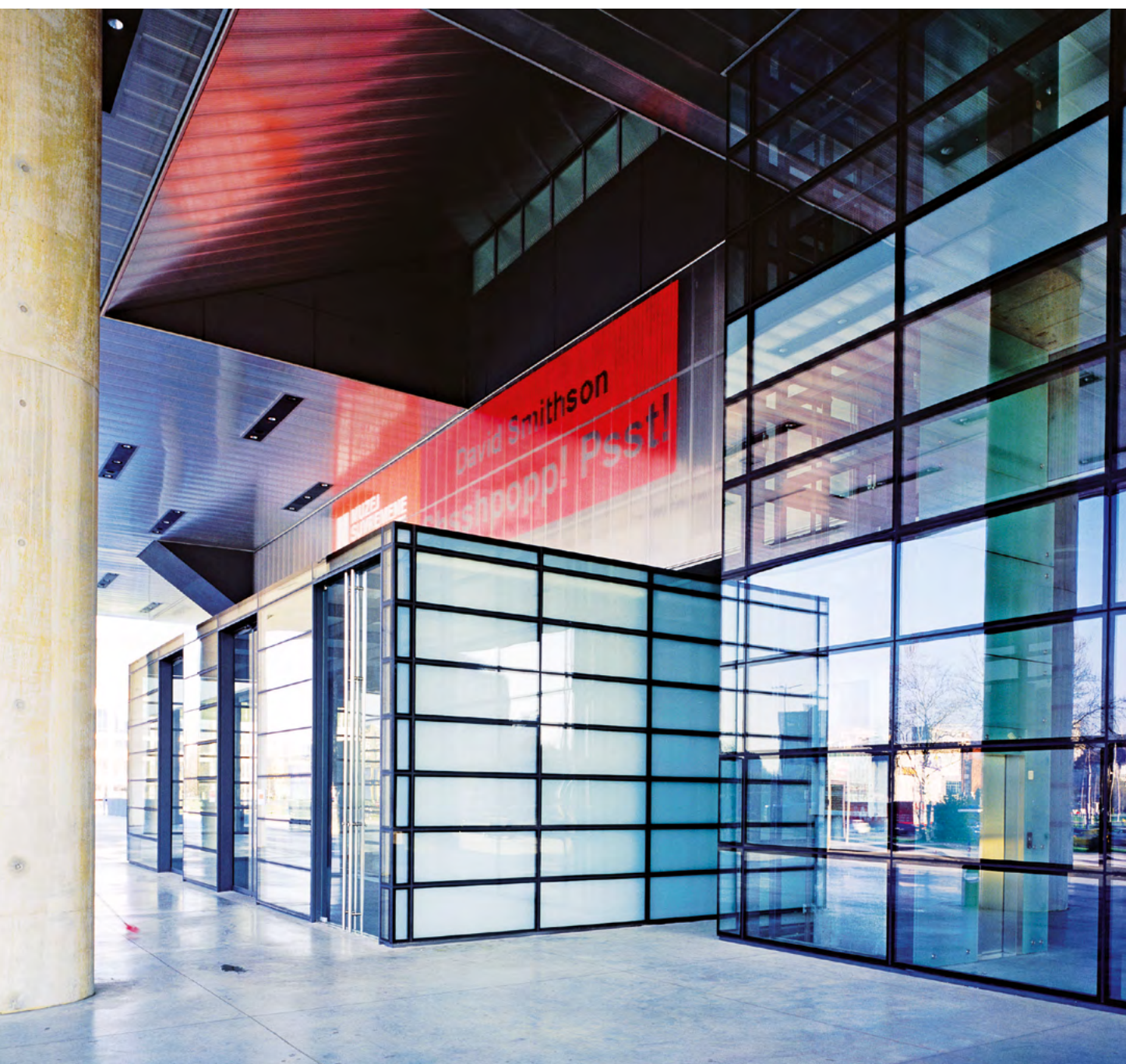



Ausgeführte Objekte  
Objets réalisés  
Completed projects



**Objekt:**

Museum für Kunst und  
Kulturgeschichte Altona,  
Hamburg-Altona/DE

**System:**

VISS I<sub>x</sub>tra, Janisol 2 EI30

**Architekt:**

Störmer Murphy and Partners GbR,  
Hamburg/DE

**Objet:**

Musée de l'art et de l'histoire  
de la civilisation Altona,  
Hambourg-Altona/DE

**Système:**

VISS I<sub>x</sub>tra, Janisol 2 EI30

**Architecte:**

Störmer Murphy and Partners GbR,  
Hambourg/DE

**Project:**

Altona Museum of Art and  
Cultural History Altona,  
Hamburg-Altona/DE

**System:**

VISS I<sub>x</sub>tra, Janisol 2 EI30

**Architect:**

Störmer Murphy and Partners GbR,  
Hamburg/DE



Fotos: Jochen Helle, Dortmund

**Objekt:**

TransPort (Flughafen Schiphol),  
Amsterdam/NL

**System:**

VISS Basic TVS Fire, VISS TVS

**Architekt:**

Architectenbureau Paul de Ruiter,  
Amsterdam/NL

**Objet:**

TransPort (aéroport Schiphol),  
Amsterdam/NL

**Système:**

VISS Basic TVS Fire, VISS TVS

**Architecte:**

Architectenbureau Paul de Ruiter,  
Amsterdam/NL

**Project:**

TransPort (Schiphol airport),  
Amsterdam/NL

**System:**

VISS Basic TVS Fire, VISS TVS

**Architect:**

Architectenbureau Paul de Ruiter,  
Amsterdam/NL



Fotos. Pieter Kers/NL

# Ausgeführte Objekte

## Objets réalisés

### Completed projects

**Objekt:**

Büro- und Geschäftshaus «Hillsite»,  
Schwalbach am Taunus/DE

**System:**

VISS Semi SG

**Architekt:**

Meixner-Schlüter-Wendt Architekten,  
Frankfurt am Main/DE

**Objet:**

Immeuble de bureaux et de commerce  
«Hillsite», Schwalbach am Taunus/DE

**Système:**

VISS Semi SG

**Architecte:**

Meixner-Schlüter-Wendt Architekten,  
Frankfurt am Main/DE

**Project:**

«Hillsite» office complex,  
Schwalbach am Taunus/DE

**System:**

VISS Semi SG

**Architect:**

Meixner-Schlüter-Wendt Architekten,  
Frankfurt am Main/DE

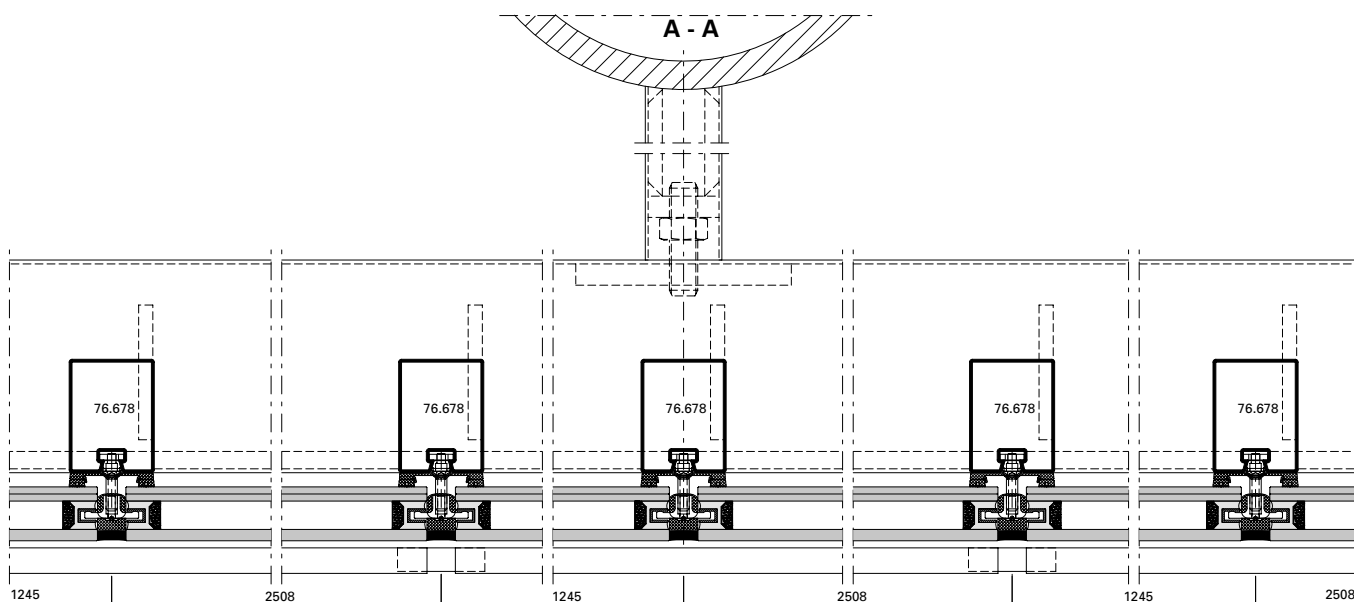

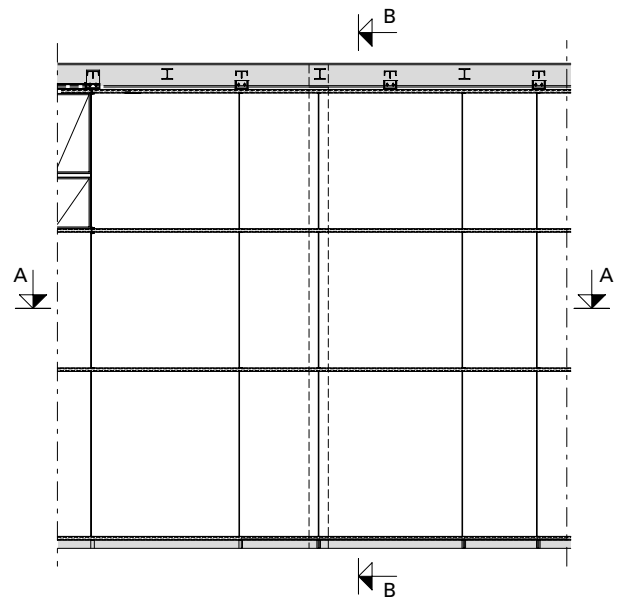
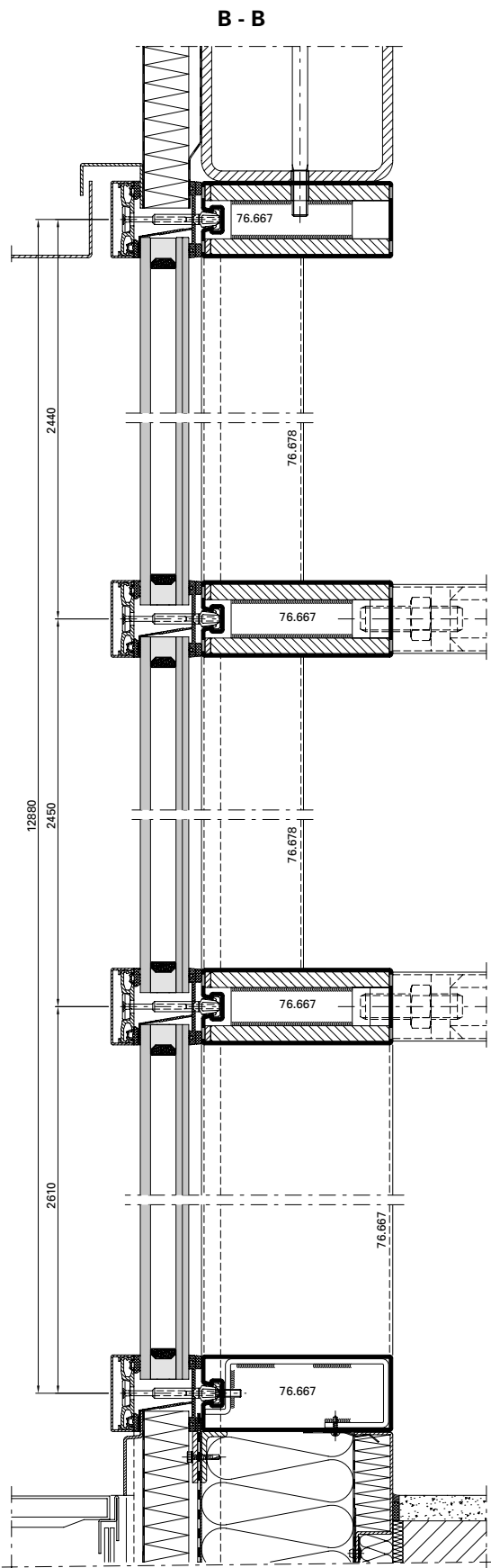

# Ausgeführte Objekte Objets réalisés Completed projects

**Objekt:**

Zentralarchiv EDF, Bure/FR

**System:**

VISS TVS, Janisol Türen Edelstahl

**Architekt:**

LAN (Local Architecture Network),  
Paris/FR

**Objet:**

Centre d'archives EDF, Bure/FR

**Système:**

VISS TVS, portes Janisol acier Inox

**Architecte:**

LAN (Local Architecture Network), Paris/  
FR

**Project:**

Central archive EDF, Bure/FR

**System:**

VISS TVS, Janisol doors stainless steel

**Architect:**

LAN (Local Architecture Network),  
Paris/FR

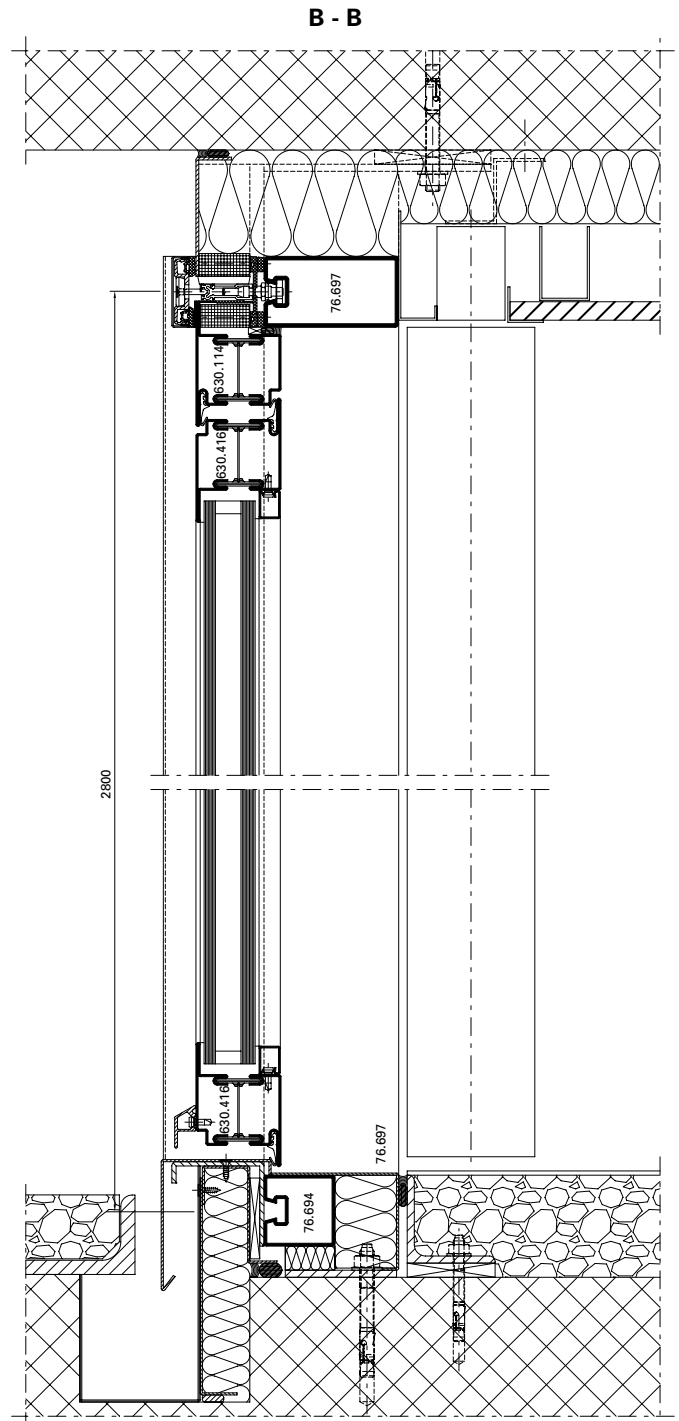



A - A

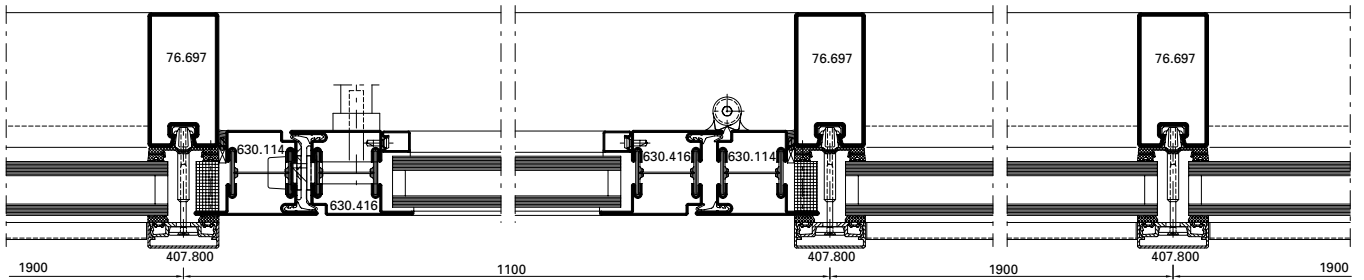

B

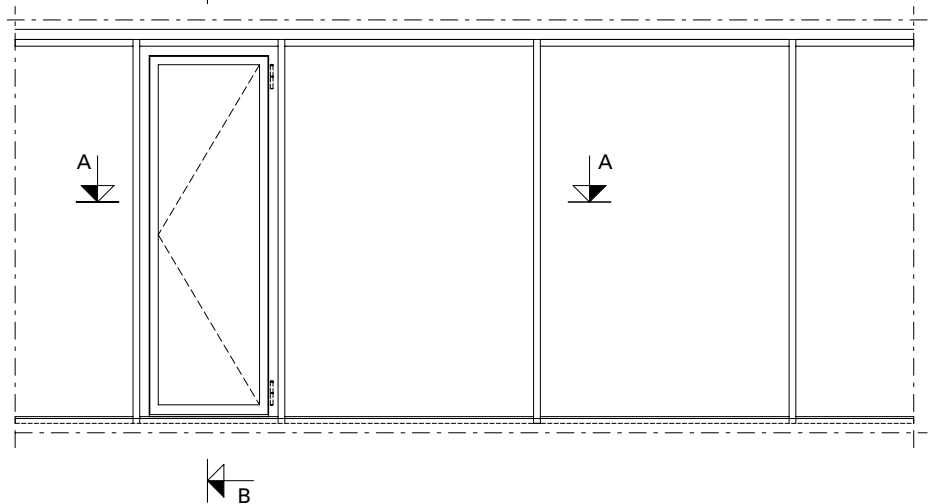

# Ausgeführte Objekte

## Objets réalisés

### Completed projects

**Objekt:**

Gemeindehaus,  
Ruidellots de la Selva/ES

**System:**

VISS TVS

**Architekt:**

Pla & Padrosa S.A., Girona/ES

**Objet:**

Hôtel de ville,  
Ruidellots de la Selva/ES

**Système:**

VISS TVS

**Architecte:**

Pla & Padrosa S.A., Girona/ES

**Project:**

Town hall,  
Ruidellots de la Selva/ES

**System:**

VISS TVS

**Architect:**

Pla & Padrosa S.A., Girona/ES

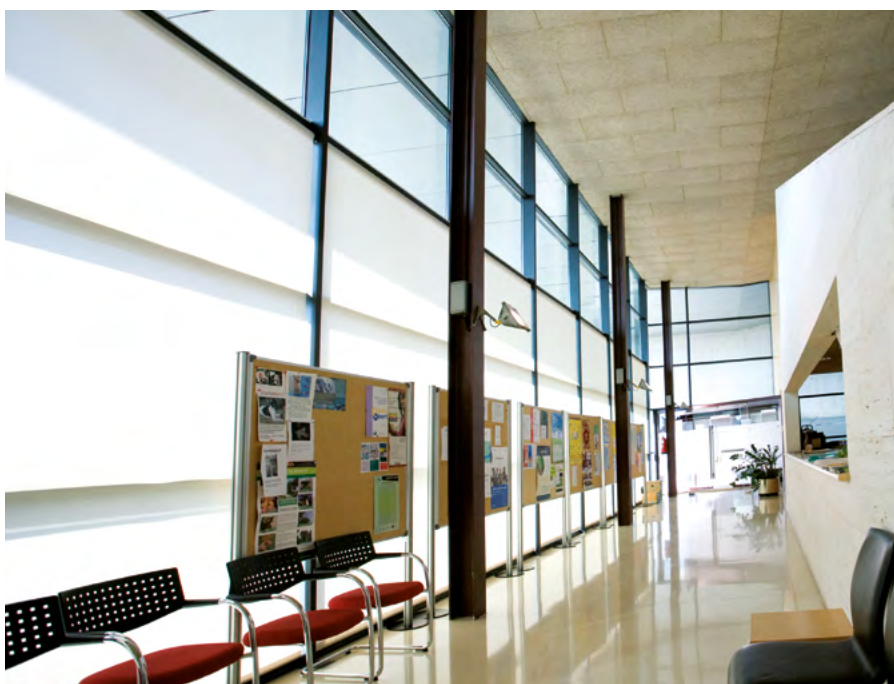

**Objekt:**

Hauptbahnhof, Köln/DE

**System:**

VISS TV, Jansen-Economy 50 Türen,  
Janisol Türen Edelstahl

**Architekt:**

Kopka und Theil Architekten,  
Dortmund/DE

**Objet:**

Gare centrale, Cologne/DE

**Système:**

VISS TV, portes Jansen-Economy 50,  
portes Janisol acier Inox

**Architecte:**

Kopka und Theil Architekten,  
Dortmund/DE

**Project:**

Central station, Cologne/DE

**System:**

VISS TV, Jansen-Economy 50 doors,  
Janisol stainless steel doors

**Architect:**

Kopka und Theil Architekten,  
Dortmund/DE

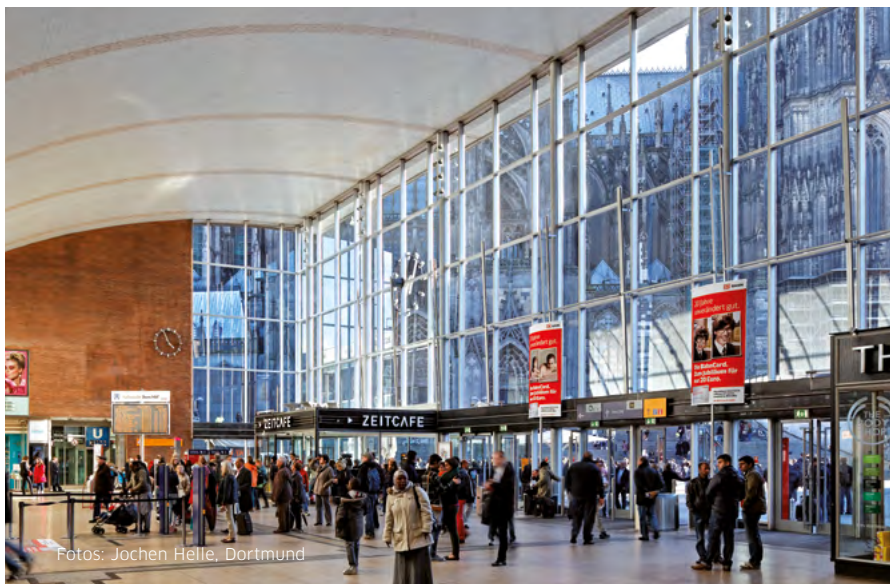

# Ausgeführte Objekte Objets réalisés Completed projects

**Objekt:**

UNIL, Universität Lausanne «Géopolis»,  
Lausanne/CH

**System:**

VISS Fire, VISS TV, Janisol 2 EI30

**Architekt:**

Itten + Brechbühl Architekten,  
Büro Lausanne, Lausanne/CH

**Objet:**

UNIL, Université de Lausanne  
«Géopolis», Lausanne/CH

**Système:**

VISS Fire, VISS TV, Janisol 2 EI30

**Architecte:**

Itten + Brechbühl Architekten,  
Büro Lausanne, Lausanne/CH

**Project:**

UNIL, University of Lausanne  
«Géopolis», Lausanne/CH

**System:**

VISS Fire, VISS TV, Janisol 2 EI30

**Architect:**

Itten + Brechbühl Architekten,  
Büro Lausanne, Lausanne/CH

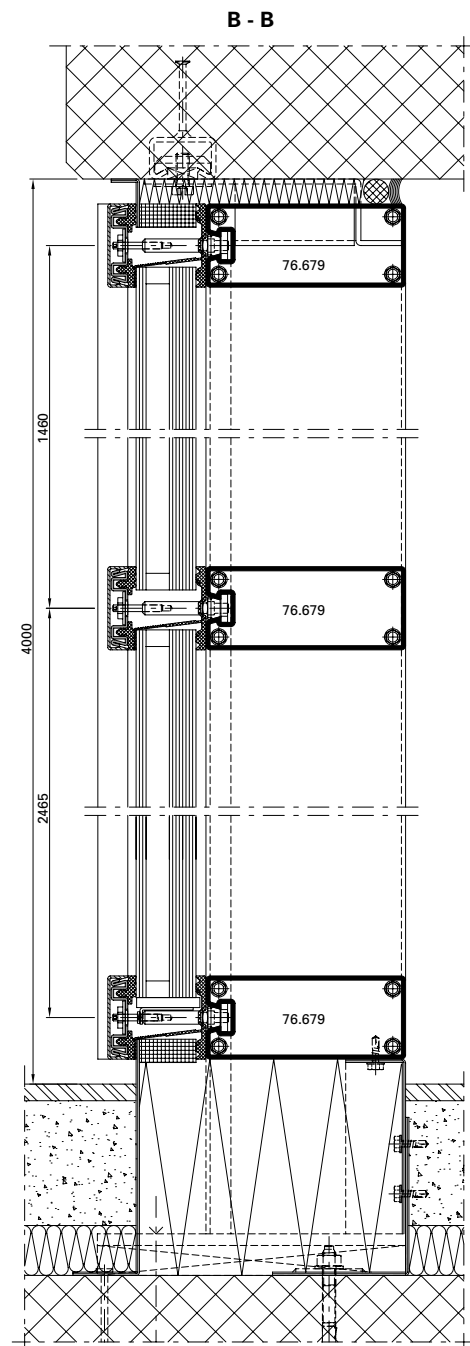

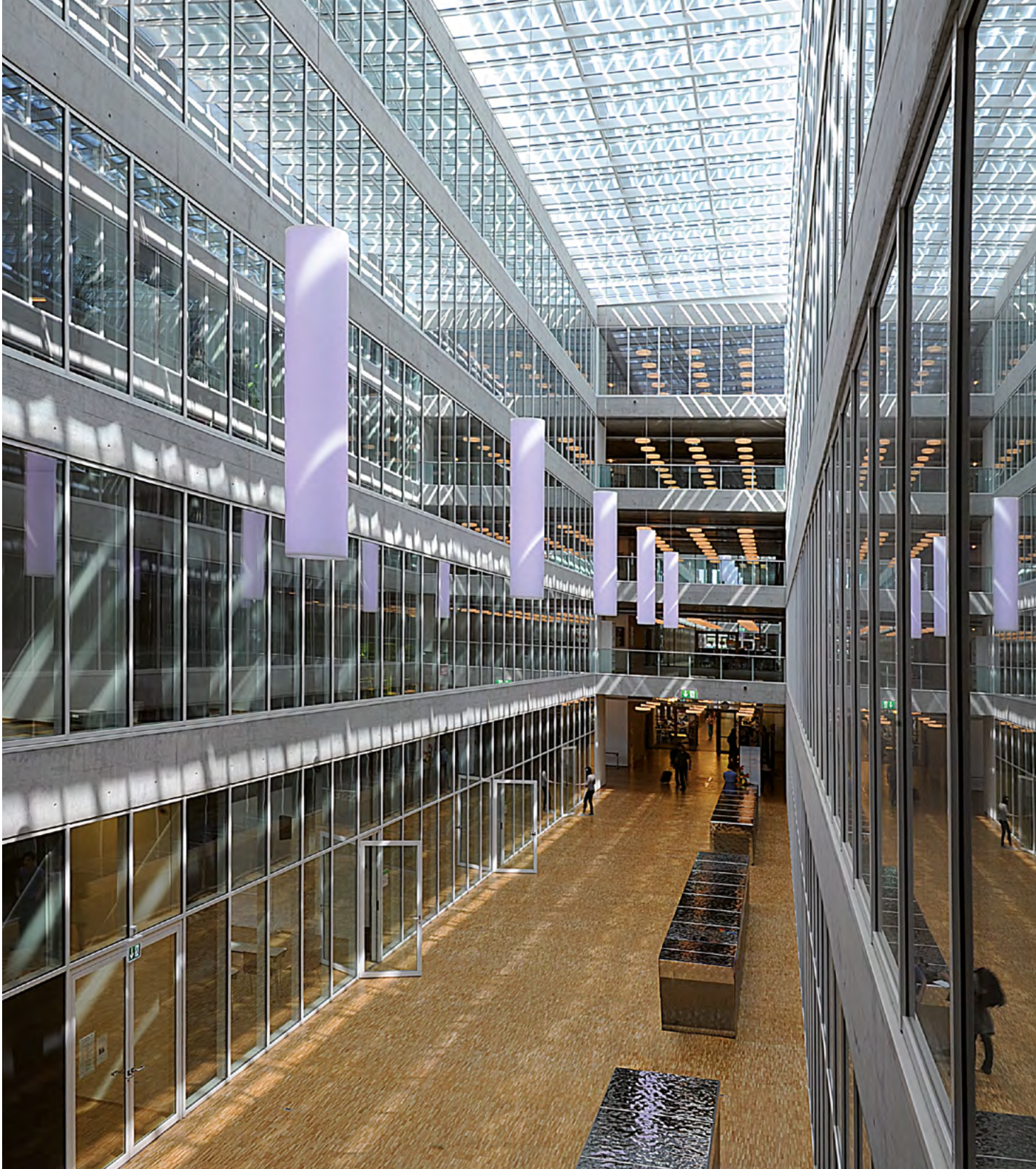

A - A

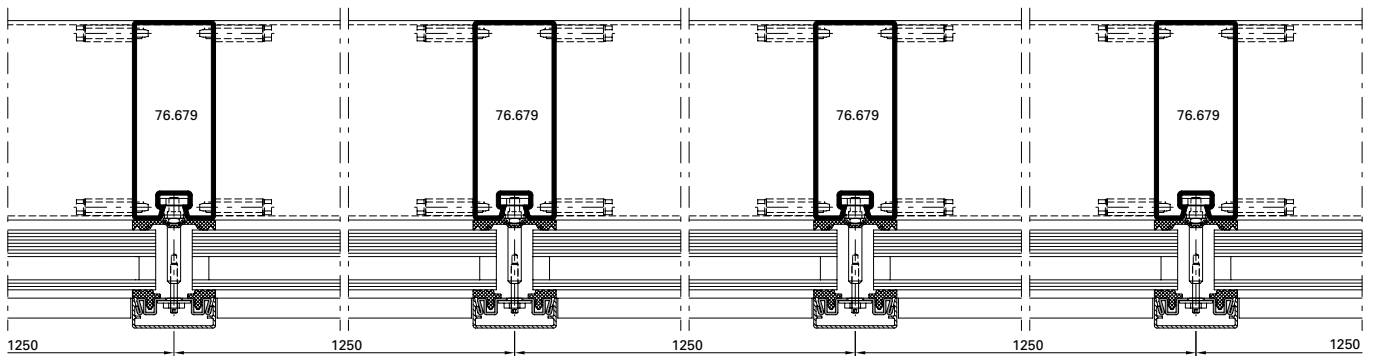

# Ausgeführte Objekte

## Objets réalisés

### Completed projects

**Objekt:**

Jansen AG, Campus, Oberriet/CH

**System:**

VISS SG

**Architekt:**

Davide Macullo Architects, Lugano/CH

**Objet:**

Jansen AG, Campus, Oberriet/CH

**Système:**

VISS SG

**Architecte:**

Davide Macullo Architects, Lugano/CH

**Project:**

Jansen AG, Campus, Oberriet/CH

**System:**

VISS SG

**Architect:**

Davide Macullo Architects, Lugano/CH

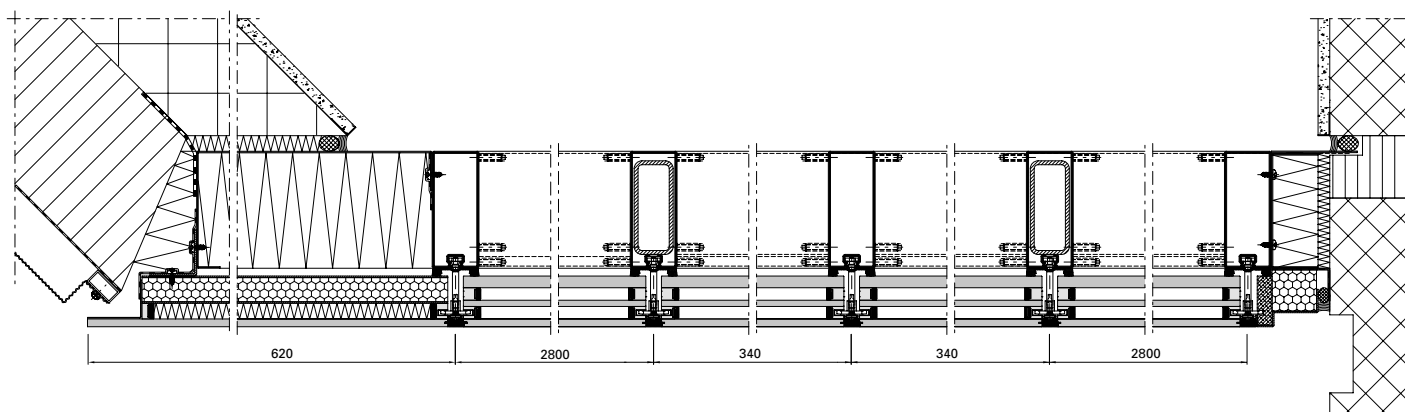

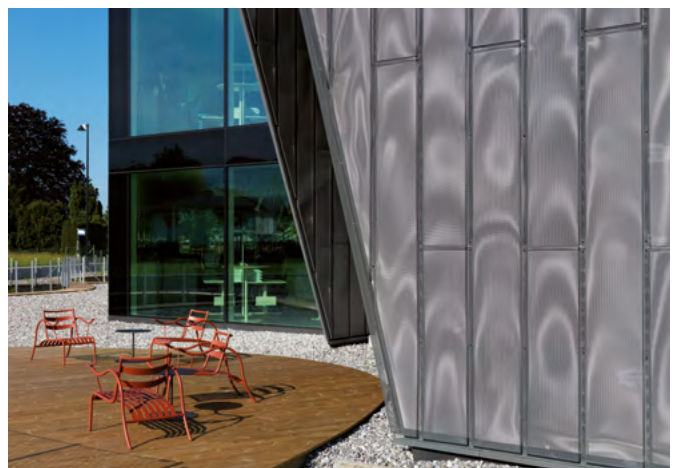
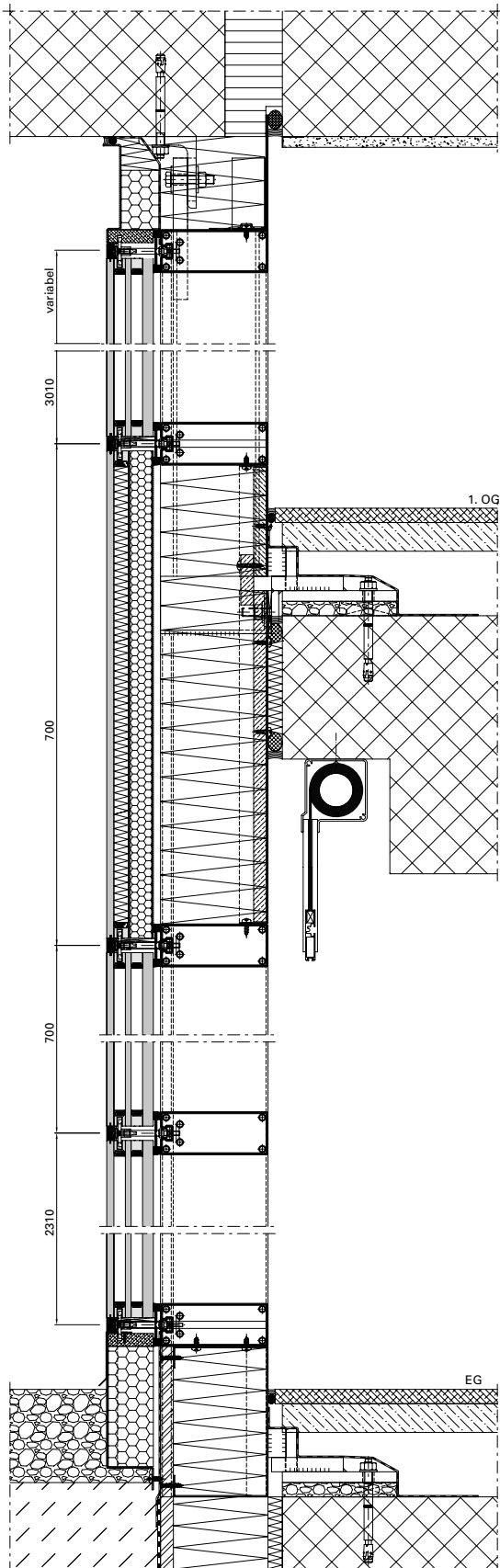

# Ausgeführte Objekte

## Objets réalisés

### Completed projects

**Objekt:**

Bildungsforum, Potsdam/DE

**System:**

VISS TVS HI, VISS Fire

**Architekt:**

Reiner Becker Architekten BDA, Berlin/  
DE

**Objet:**

Forum de formation, Potsdam/DE

**Système:**

VISS TVS HI, VISS Fire

**Architecte:**

Reiner Becker Architekten BDA, Berlin/  
DE

**Project:**

Education forum, Potsdam/DE

**System:**

VISS TVS HI, VISS Fire

**Architect:**

Reiner Becker Architekten BDA, Berlin/  
DE

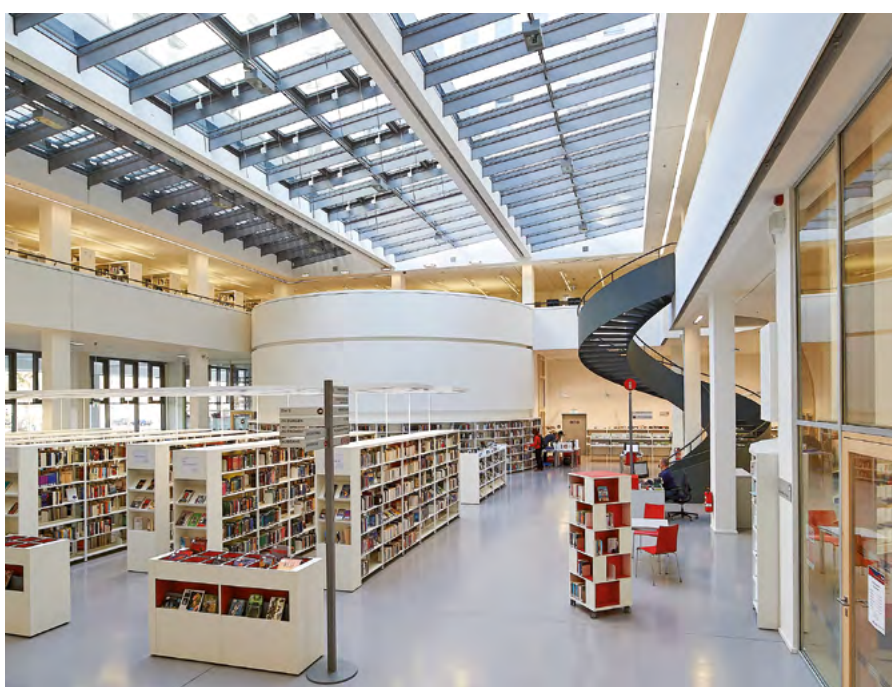





Fotos: Stephan Falk, Berlin



# Ausgeführte Objekte

## Objets réalisés

## Completed projects

**Objekt:**

Besucherzentrum «Alte Wasserzentrale», Pietra Neamt/RO

**System:**

VISS TVS

**Architekt:**

ZIP & BDX Studio, Marius Calin, Bukarest/RO

**Objet:**

Centre de visiteurs «ancienne centrale des eaux», Pietra Neamt/RO

**Système:**

VISS TVS

**Architecte:**

ZIP & BDX Studio, Marius Calin, Bukarest/RO

**Project:**

Visitor centre «old water station», Pietra Neamt/RO

**System:**

VISS TVS

**Architect:**

ZIP & BDX Studio, Marius Calin, Bukarest/RO

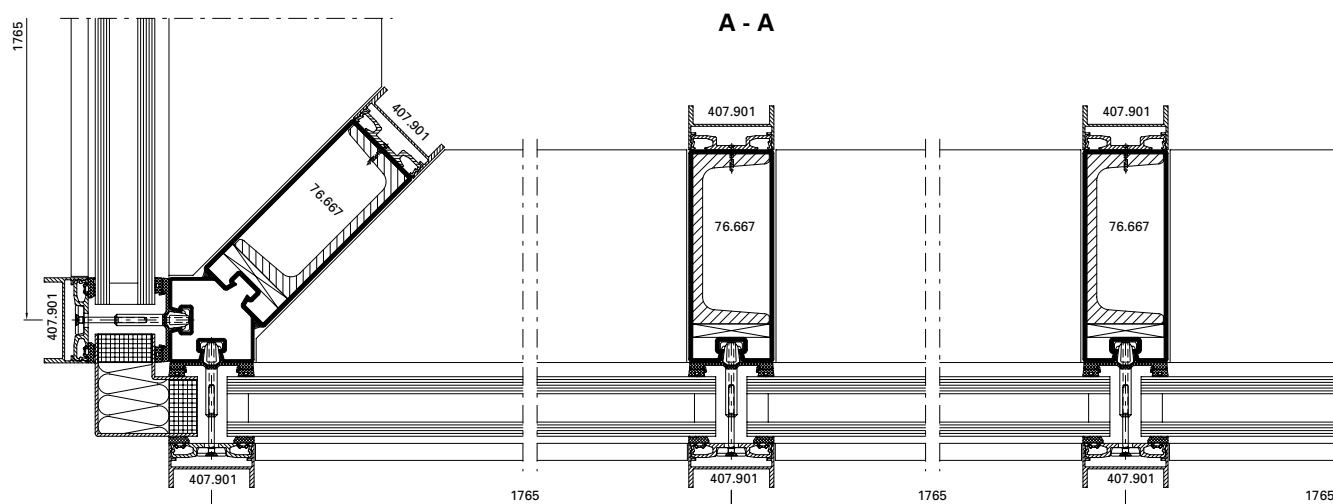
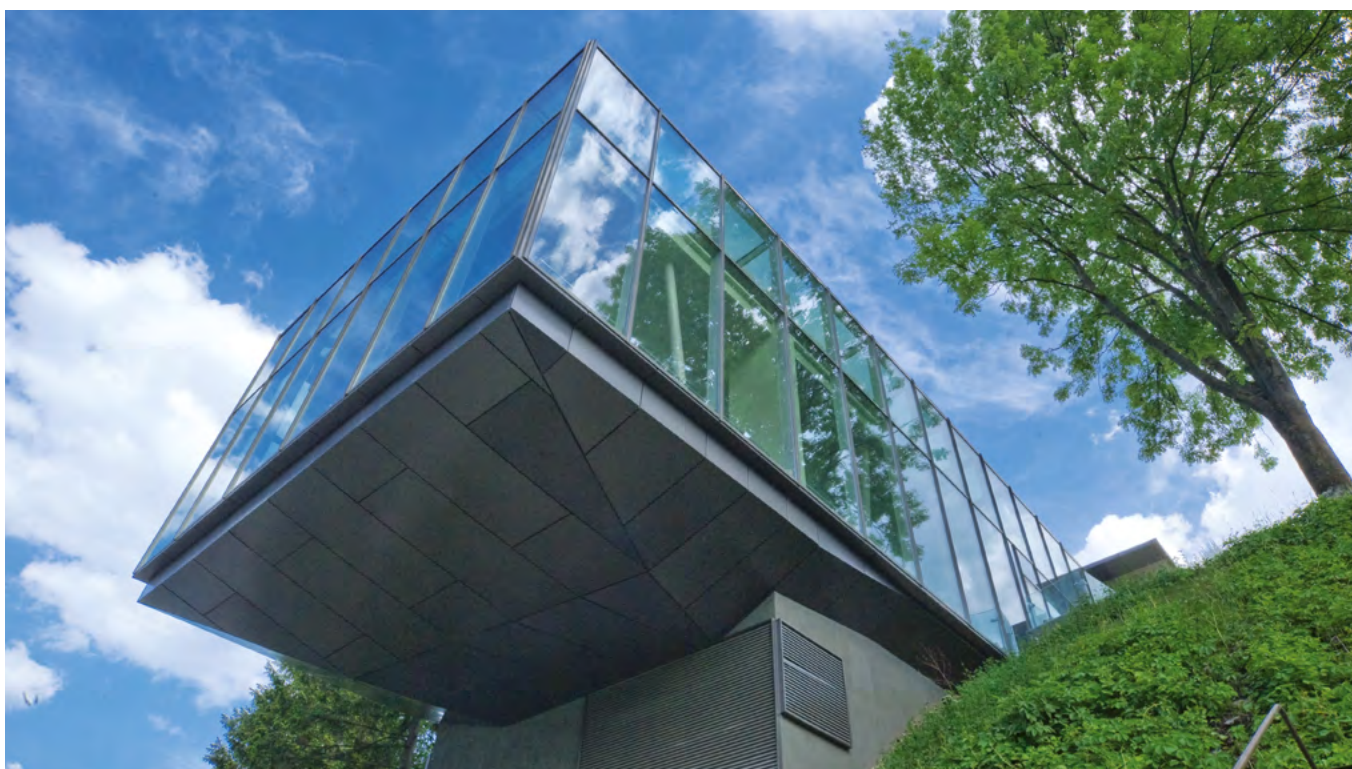

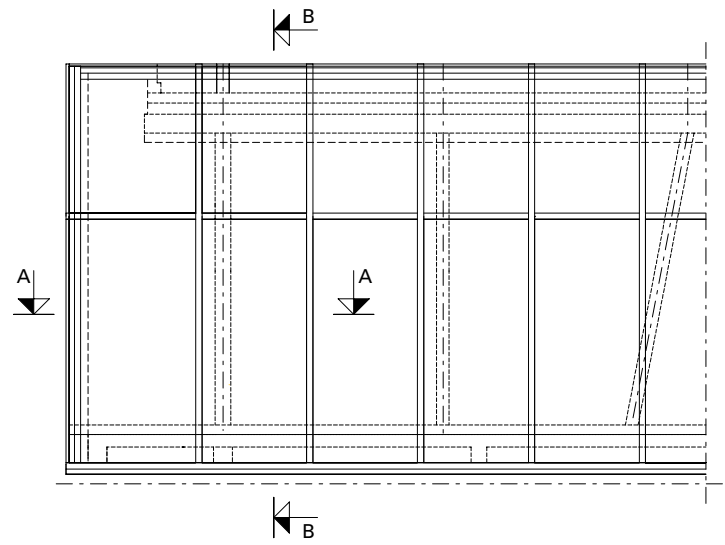
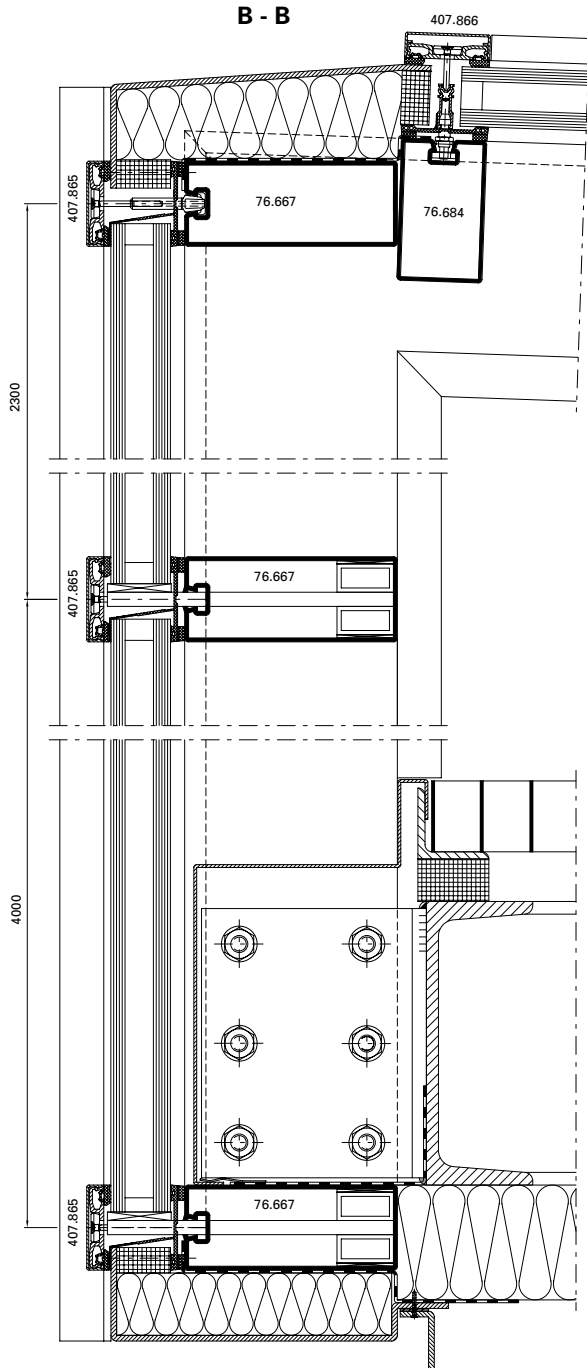

# Ausgeführte Objekte

## Objets réalisés

### Completed projects

**Objekt:**

Hotel Novi Spa,  
Novi Vinodolski/HR

**System:**

VISS TV Linea

**Architekt:**

Architekturstudio Banas und Cimas,  
Rijeka/HR

**Objet:**

Hôtel Novi Spa,  
Novi Vinodolski/HR

**Système:**

VISS TV Linea

**Architecte:**

Architekturstudio Banas und Cimas,  
Rijeka/HR

**Project:**

Novi Spa Hotel,  
Novi Vinodolski/HR

**System:**

VISS TV Linea

**Architect:**

Architekturstudio Banas und Cimas,  
Rijeka/HR



**Objekt:**

Solvias AG, Büro- und Lagergebäude, Kaiseraugst/CH

**System:**

VISS TV Linea

**Architekt:**

Zwimpfer Partner Architekten, Basel/CH

**Objet:**

Solvias AG, immeuble de bureaux et d'entrepôt, Kaiseraugst/CH

**Système:**

VISS TV Linea

**Architecte:**

Zwimpfer Partner Architekten, Bâle/CH

**Project:**

Solvias AG, office and warehouse facility, Kaiseraugst/CH

**System:**

VISS TV Linea

**Architect:**

Zwimpfer Partner Architekten, Basle/CH



# Ausgeführte Objekte

## Objets réalisés

### Completed projects

**Objekt:**

Médiathèque, Pau/FR

**System:**

VISS Fire EW60, VISS Basic,  
Janisol 3 E160

**Architekt:**

CANAL, Paris/FR

**Objet:**

Médiathèque, Pau/FR

**Système:**

VISS Fire EW60, VISS Basic,  
Janisol 3 E160

**Architecte:**

CANAL, Paris/FR

**Project:**

Médiathèque, Pau/FR

**System:**

VISS Fire EW60, VISS Basic,  
Janisol 3 E160

**Architect:**

CANAL, Paris/FR



A - A

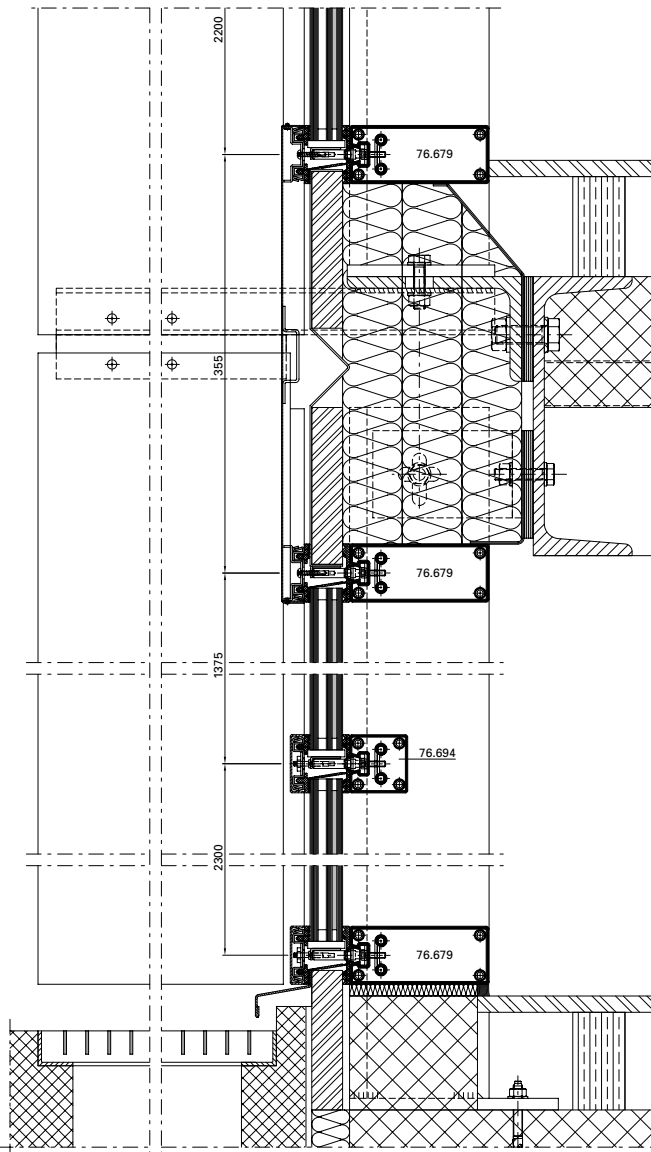

B - B

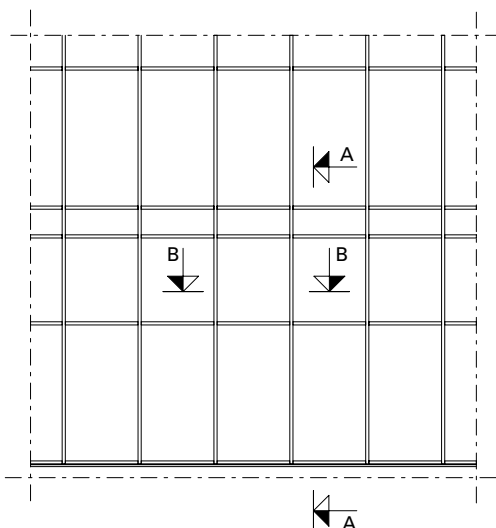
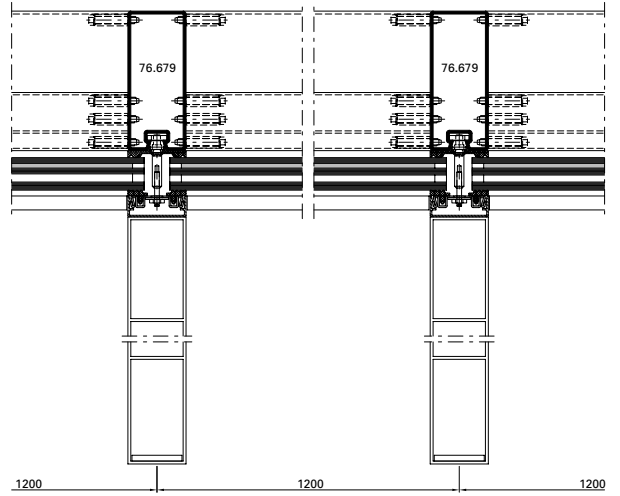

# Ausgeführte Objekte

## Objets réalisés

### Completed projects

**Objekt:**

«Mumuth» Haus für Musik & Musiktheater der Kunstuniversität, Graz/AT

**System:**

VISS TVS

**Architekt:**

UNStudio, Arch. Ben van Berkel en Bos, Amsterdam/NL

**Objet:**

«Mumuth» Maison de la musique & du théâtre musical de l'université des arts, Grace/AT

**Système:**

VISS TVS

**Architecte:**

UNStudio, Arch. Ben van Berkel en Bos, Amsterdam/NL

**Project:**

«Mumuth» House of Music & Music Drama at the University of Music and Performing Arts, Graz/AT

**System:**

VISS TVS

**Architect:**

UNStudio, Arch. Ben van Berkel en Bos, Amsterdam/NL





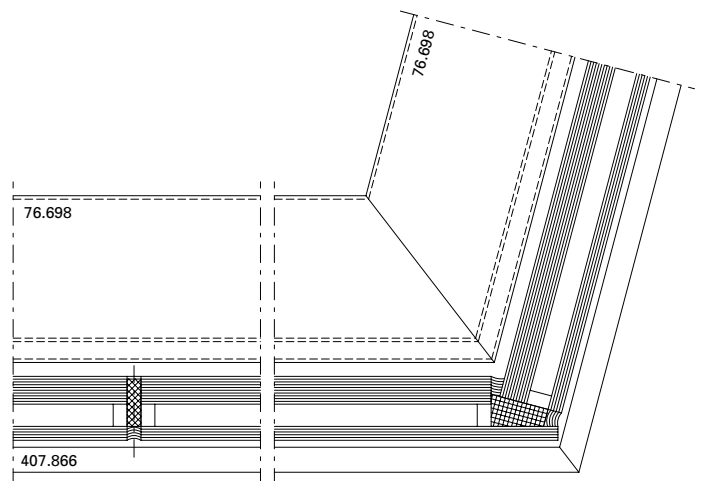
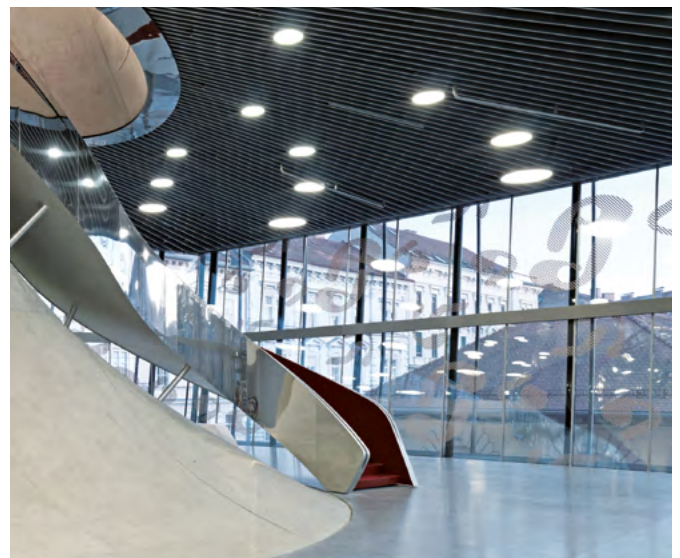
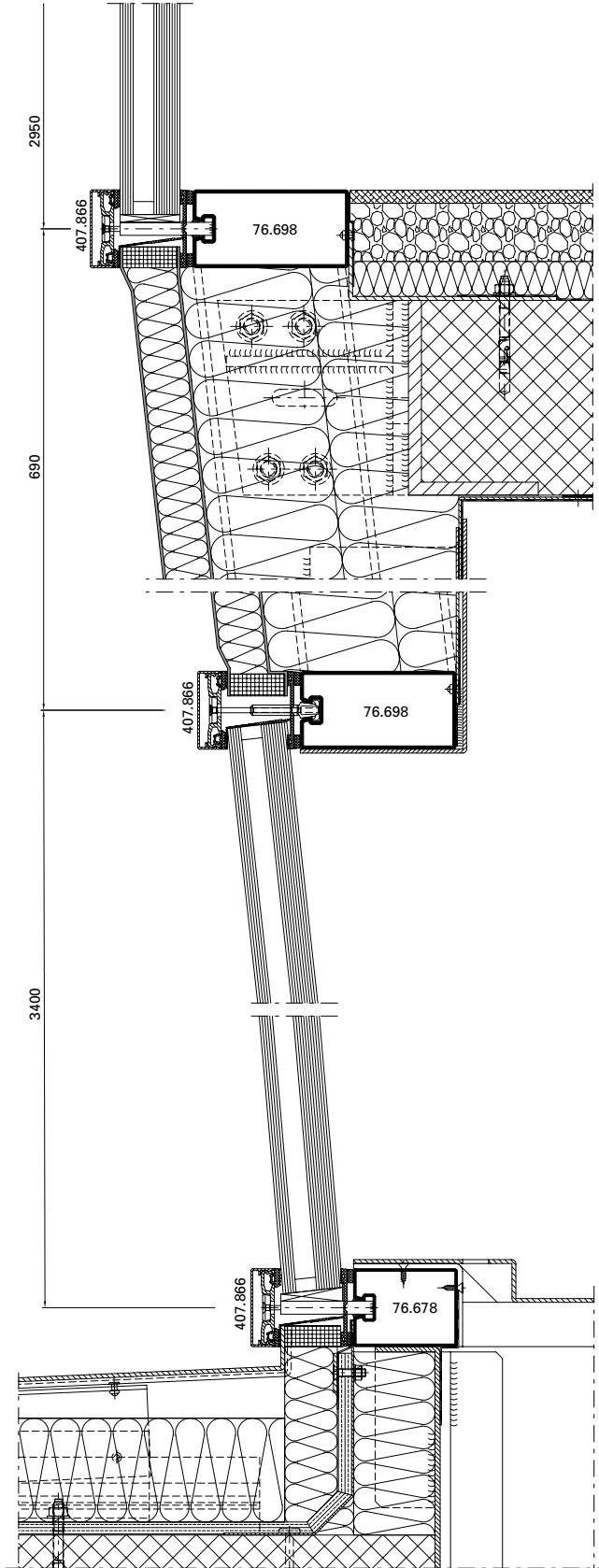

Ausgeführte Objekte  
Objets réalisés  
Completed projects



**Project:**

Centre Pompidou, Metz/FR

**System:**

VISS Fire EI60,  
Jansen-Economy 50 E30

**Architect:**

Shigeru Ban Architects, Paris/FR

**Objet:**

Centre Pompidou, Metz/FR

**Système:**

VISS Fire EI60,  
Jansen-Economy 50 E30

**Architecte:**

Shigeru Ban Architects, Paris/FR

**Objekt:**

Centre Pompidou, Metz/FR

**System:**

VISS Fire EI60,  
Jansen-Economy 50 E30

**Architekt:**

Shigeru Ban Architects, Paris/FR



**Objekt:**

Alters- und Pflegeheim,  
Burgdorf/CH

**System:**

VISS Basic TV

**Architekt:**

Gauer Itten Messerli Architekten AG,  
Bern/CH

**Objet:**

Home pour personnes âgées, Burgdorf/  
CH

**Système:**

VISS Basic TV

**Architecte:**

Gauer Itten Messerli Architekten AG,  
Bern/CH

**Project:**

Old-age and nursing home, Burgdorf/  
CH

**System:**

VISS Basic TV

**Architect:**

Gauer Itten Messerli Architekten AG,  
Bern/CH

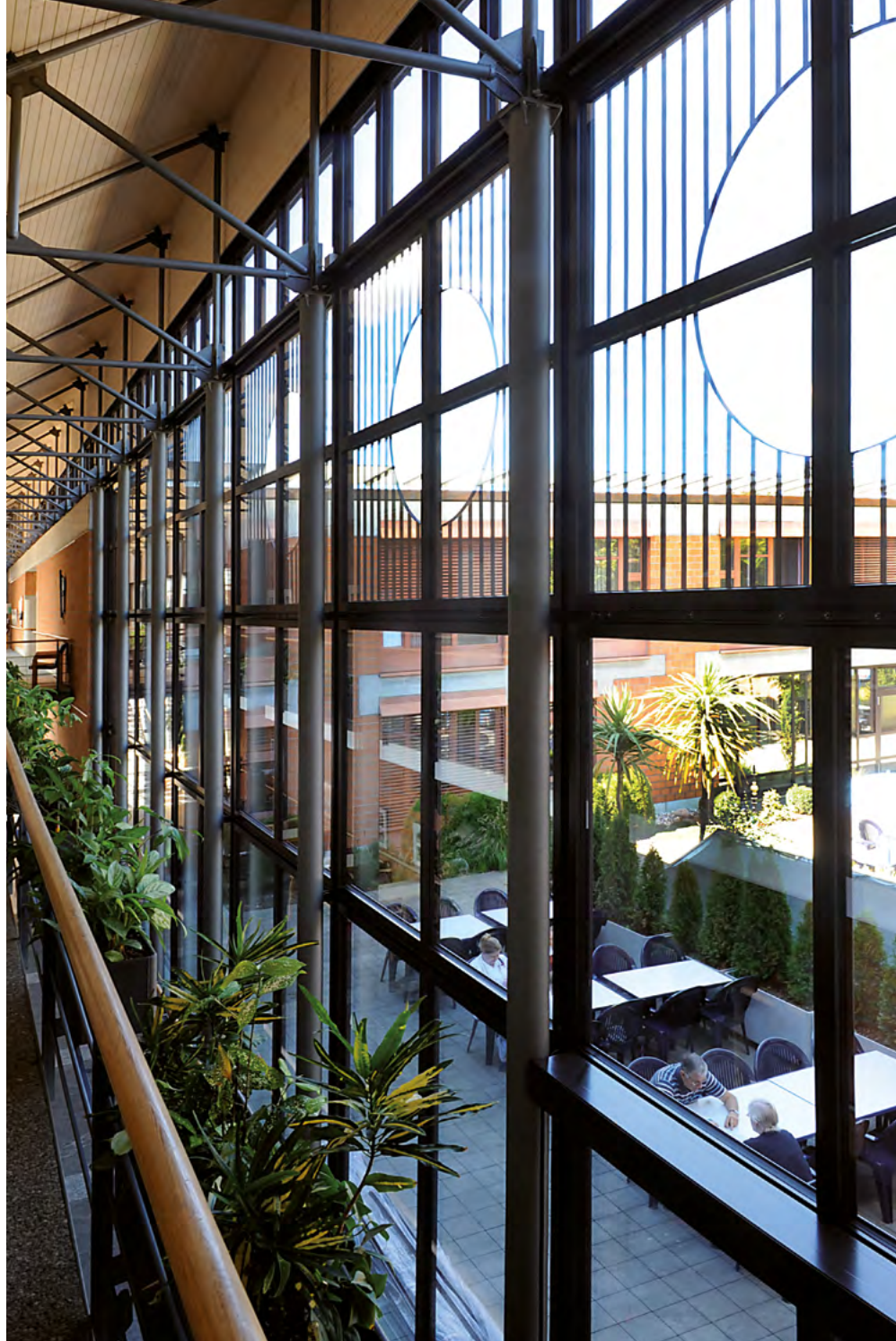

# Ausgeführte Objekte

## Objets réalisés

### Completed projects

**Objekt:**

Drents Museum, Assen/NL

**System:**

VISS Basic TV,  
Jansen-Economy 50 EW60

**Architekt:**

Designed by Erick van Egeraat,  
Rotterdam/NL

**Objet:**

Musée Drents, Assen/NL

**Système:**

VISS Basic TV,  
Jansen-Economy 50 EW60

**Architecte:**

Designed by Erick van Egeraat,  
Rotterdam/NL

**Project:**

Drents Museum, Assen/NL

**System:**

VISS Basic TV,  
Jansen-Economy 50 EW60

**Architect:**

Designed by Erick van Egeraat,  
Rotterdam/NL



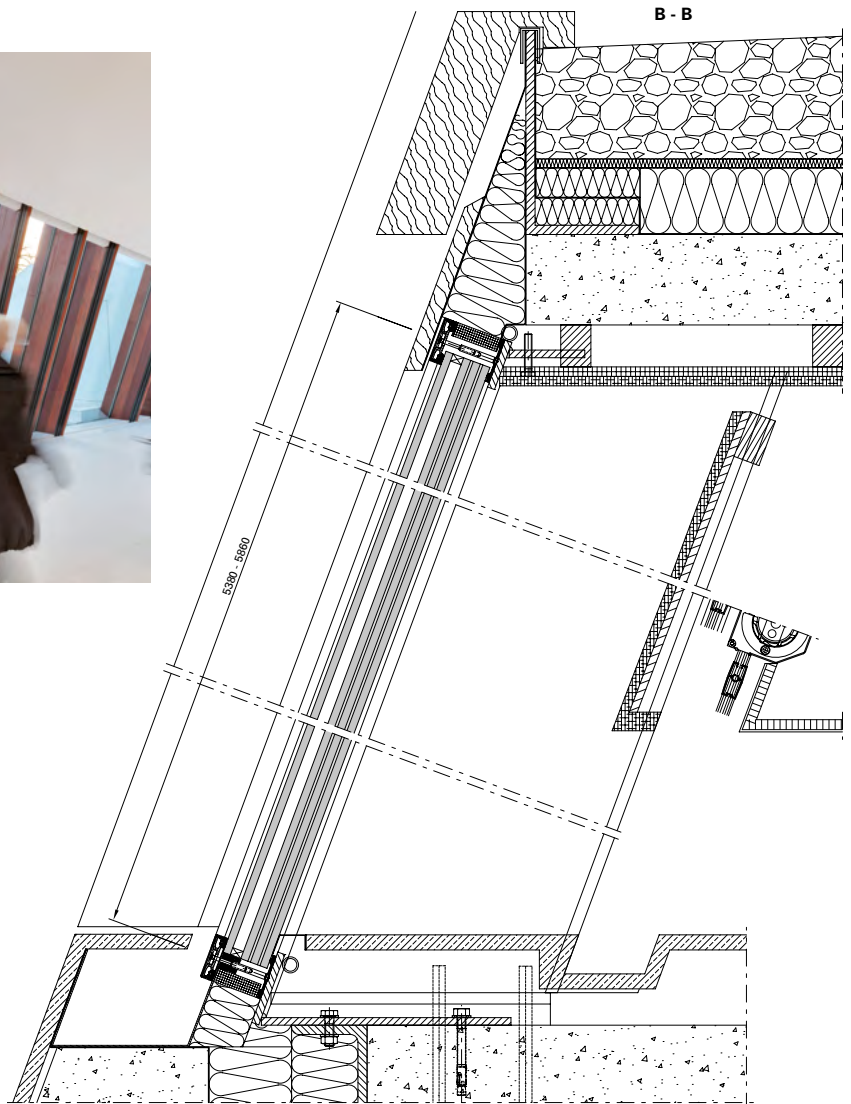
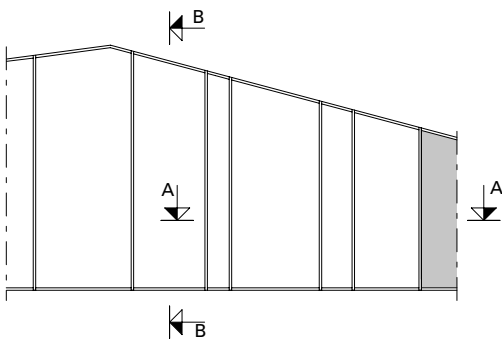
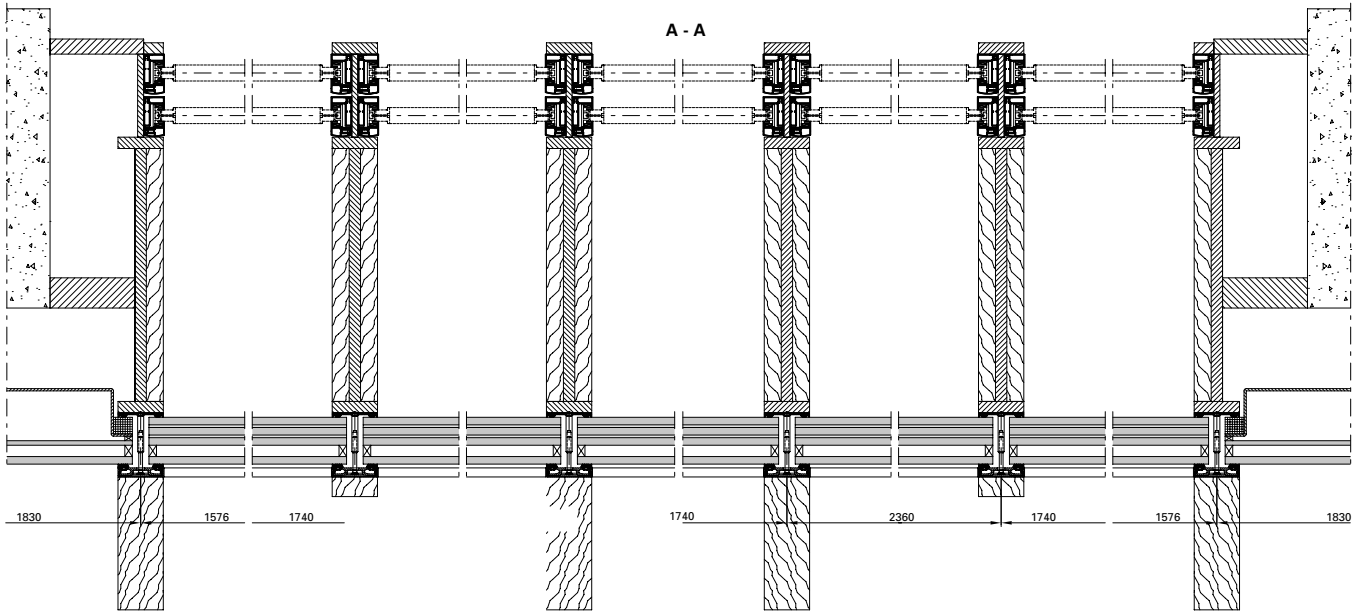

# Ausgeführte Objekte Objets réalisés Completed projects

**Objekt:**

Akkustik-Tunnels,  
Warschau/PL

**System:**

VISS Basic TVS (schräg)

**Architekt:**

Transprojekt, Warschau/PL  
FOROOM Bartłomiej Grotte,  
Warschau/PL

**Objet:**

Tunnels acoustiques,  
Varsovie/PL

**Système:**

VISS Basic TVS (oblique)

**Architecte:**

Transprojekt, Varsovie/PL  
FOROOM Bartłomiej Grotte,  
Varsovie/PL

**Project:**

Acoustic tunnels,  
Warsaw/PL

**System:**

VISS Basic TVS (sloping)

**Architect:**

Transprojekt, Warsaw/PL  
FOROOM Bartłomiej Grotte,  
Warsaw/PL

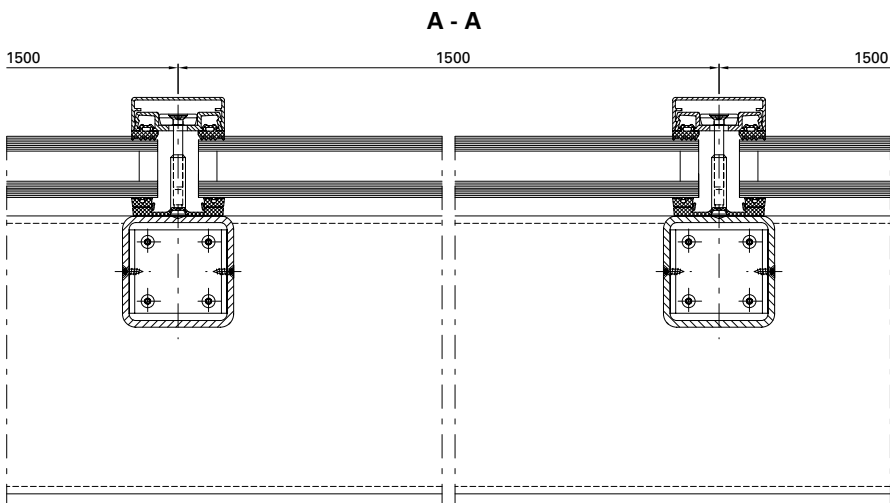

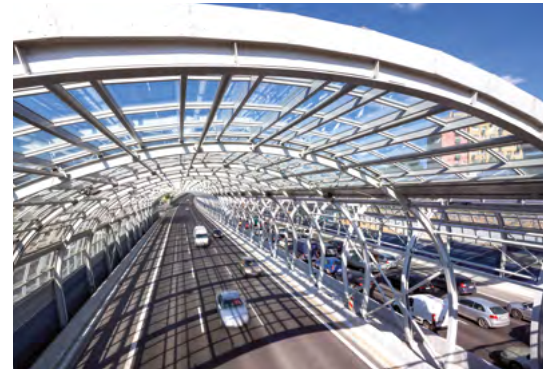
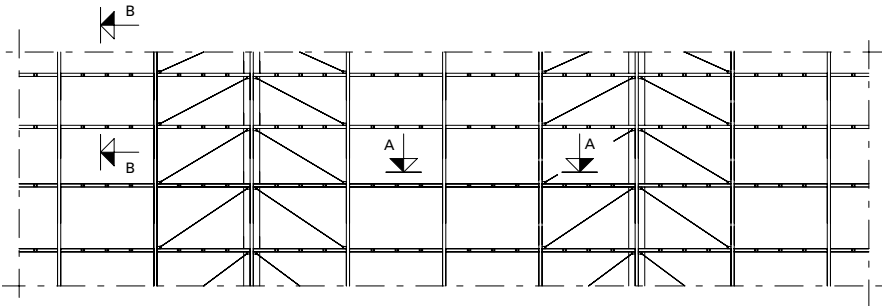
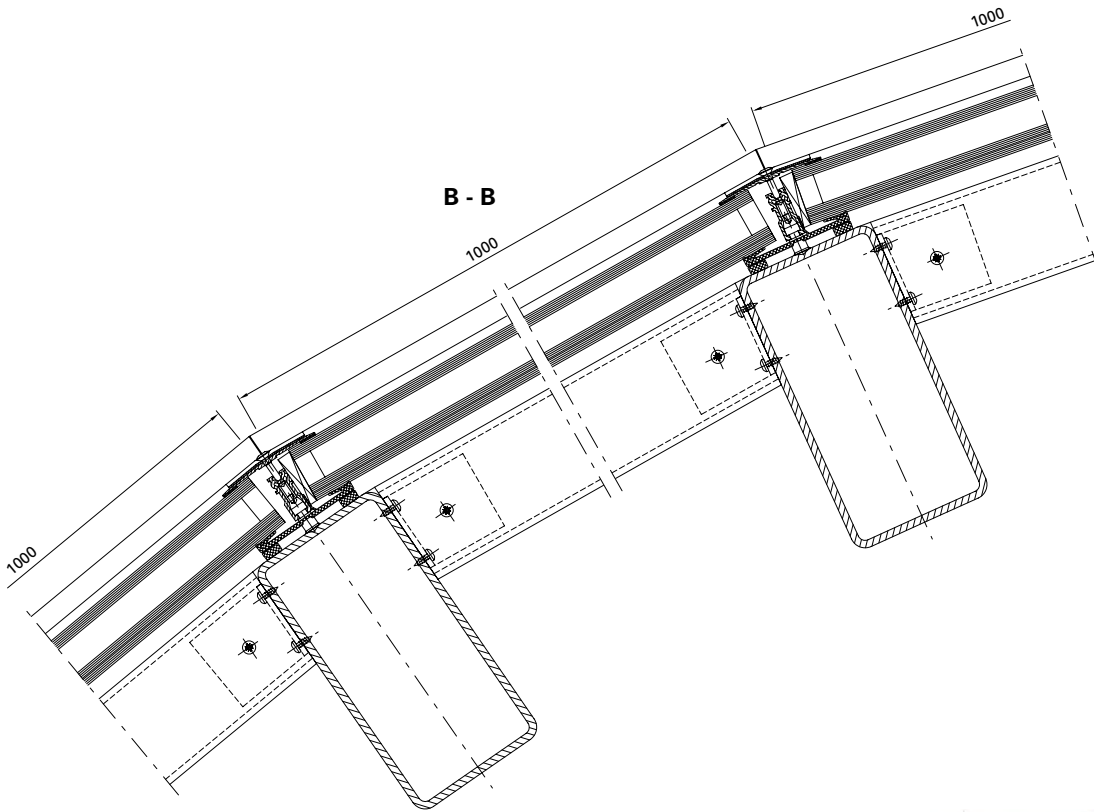

# Ausgeführte Objekte

## Objets réalisés

### Completed projects

**Objekt:**

Jin Ji Hu Kempinski Hotel, Suzhou/CN

**System:**

VISS TV

**Architekt:**

Suzhou Architecture and Design  
Institute, Shanghai/CN

**Objet:**

Hôtel Jin Ji Hu Kempinski, Suzhou/CN

**Système:**

VISS TV

**Architecte:**

Suzhou Architecture and Design  
Institute, Shanghai/CN

**Project:**

Jin Ji Hu Kempinski Hotel, Suzhou/CN

**System:**

VISS TV

**Architect:**

Suzhou Architecture and Design  
Institute, Shanghai/CN





**Objekt:**

Historisches Museum,  
Kharkov/UA

**System:**

VISS I<sub>x</sub>tra, Janisol Türen

**Architekt:**

S. Chechelnytskiy, M. Polivanova,  
T. Polivanova, Kharkov/UA

**Objet:**

Musée historique,  
Kharkov/UA

**Système:**

VISS I<sub>x</sub>tra, portes Janisol

**Architecte:**

S. Chechelnytskiy, M. Polivanova,  
T. Polivanova, Kharkov/UA

**Project:**

Historical museum,  
Kharkov/UA

**System:**

VISS I<sub>x</sub>tra, Janisol doors

**Architect:**

S. Chechelnytskiy, M. Polivanova,  
T. Polivanova, Kharkov/UA

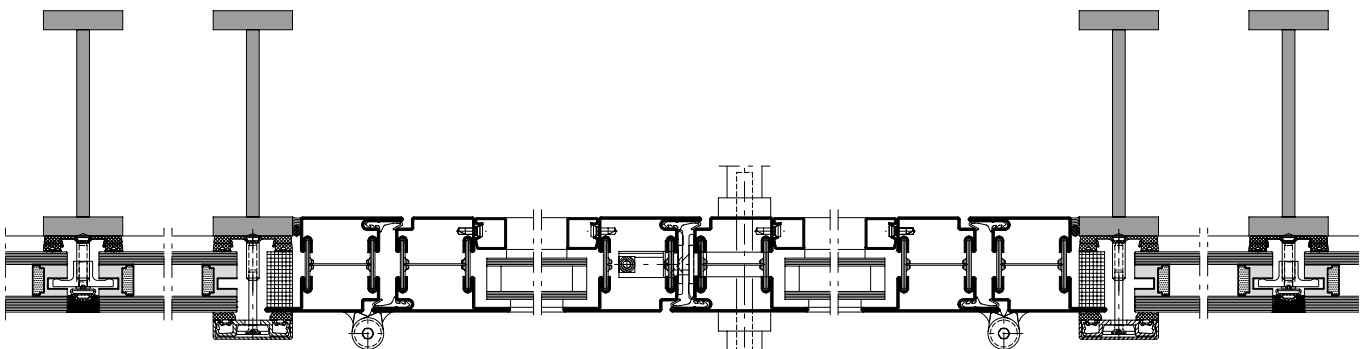

# Ausgeführte Objekte Objets réalisés Completed projects

**Objekt:**

Kunstgebäude, Stuttgart/DE

**System:**

VISS TVS (schräg)

**Architekt:**

Harder III Stumpf, Freie Architekten,  
Stuttgart/DE

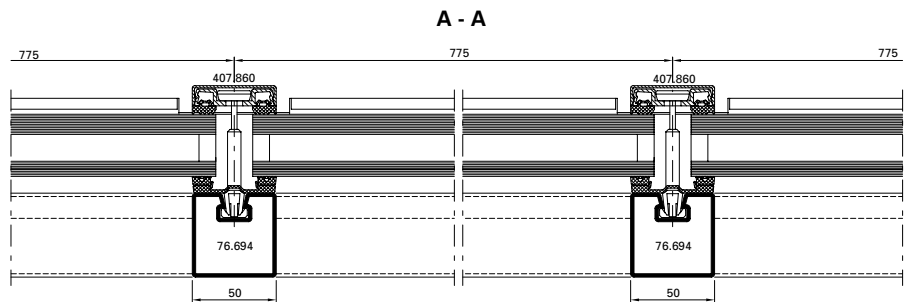
**Objet:**

Bâtiment des arts, Stuttgart/DE

**Système:**

VISS TVS (oblique)

**Architecte:**

Harder III Stumpf, Freie Architekten,  
Stuttgart/DE

**Project:**

Art building, Stuttgart/DE

**System:**

VISS TVS (sloping)

**Architect:**

Harder III Stumpf, Freie Architekten,  
Stuttgart/DE



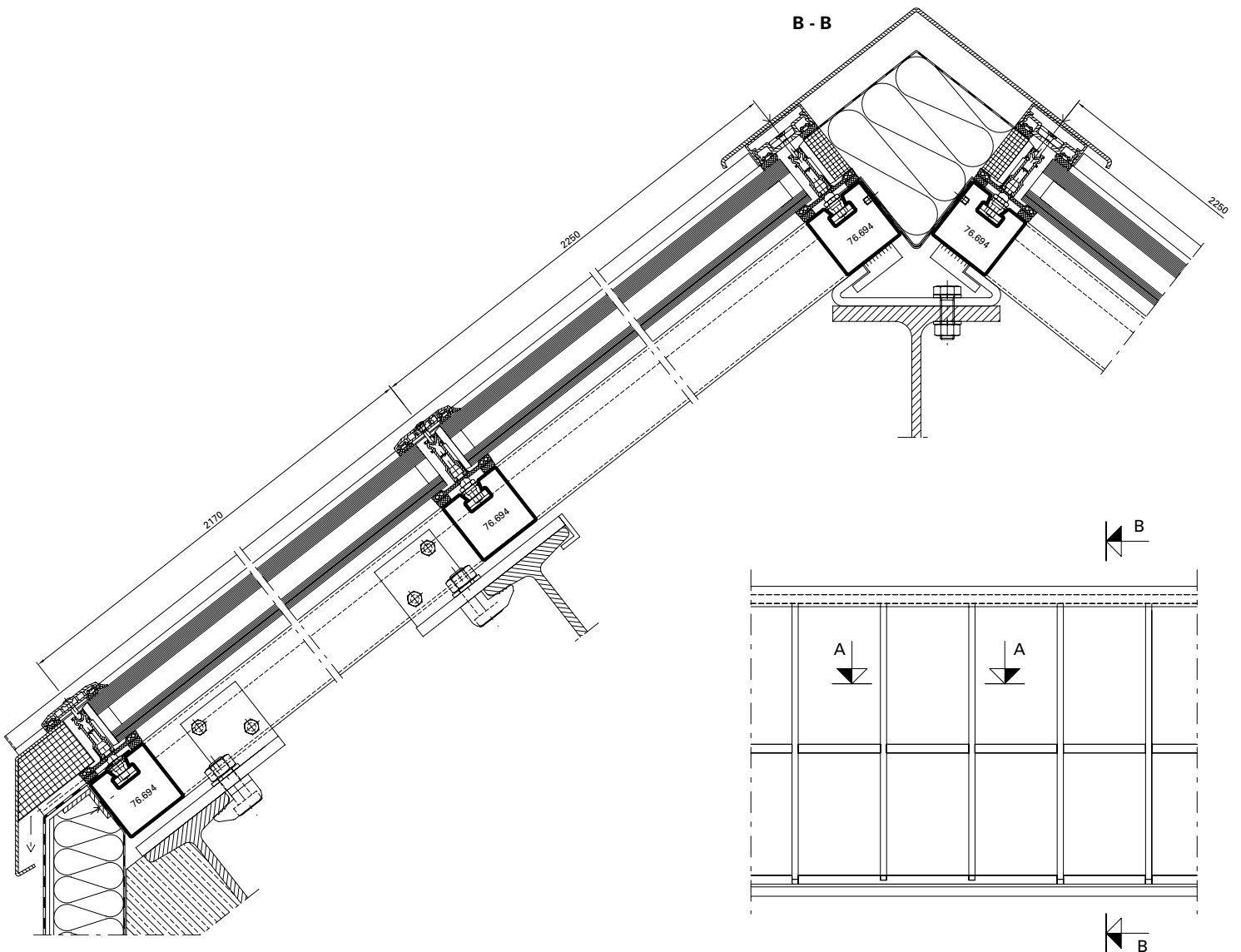

# Ausgeführte Objekte

## Objets réalisés

### Completed projects

**Objekt:**

3-Feldsporthalle, Ingelfingen/DE

**System:**

VISS TVS HI, VISS Fire E30/E90,  
Janisol Primo, Janisol Türen,  
Janisol 2 E130, Jansen-Economy 60

**Architekt:**

Hein, Hüttel und Lindenberger,  
Ludwigsburg/DE

**Objet:**

Salle de sport triple, Ingelfingen/DE

**Système:**

VISS TVS HI, VISS Fire E30/E90,  
Janisol Primo, portes Janisol,  
Janisol 2 E130, Jansen-Economy 60

**Architecte:**

Hein, Hüttel und Lindenberger,  
Ludwigsburg/DE

**Project:**

3-field sports hall, Ingelfingen/DE

**System:**

VISS TVS HI, VISS Fire E30/E90,  
Janisol Primo, Janisol doors,  
Janisol 2 E130, Jansen-Economy 60

**Architect:**

Hein, Hüttel und Lindenberger,  
Ludwigsburg/DE

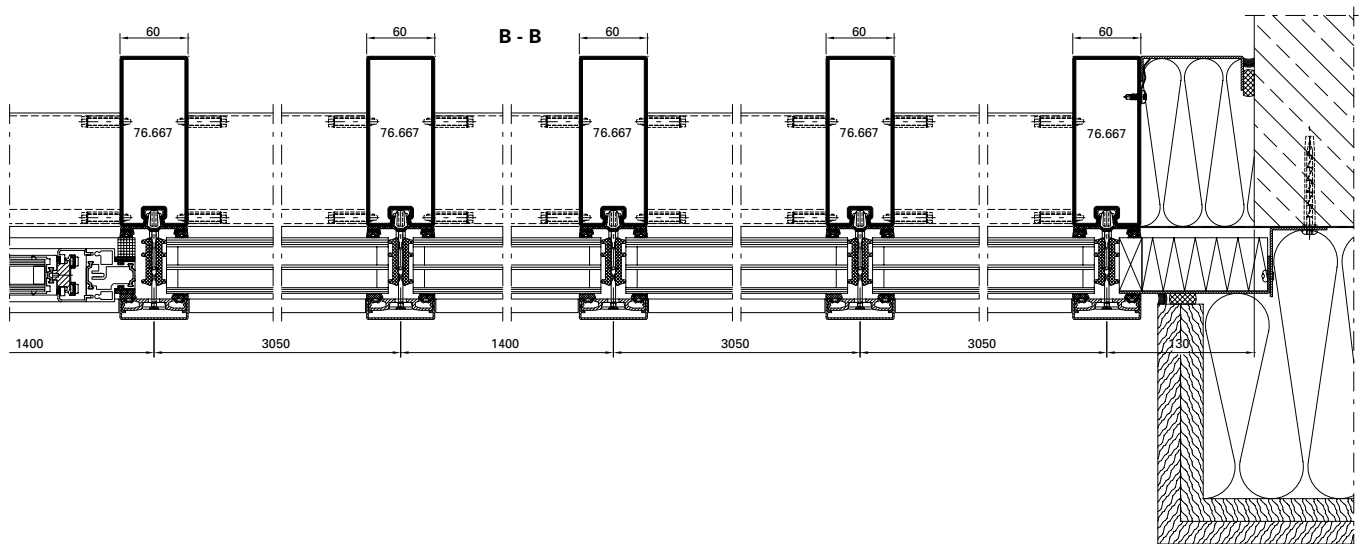

A - A

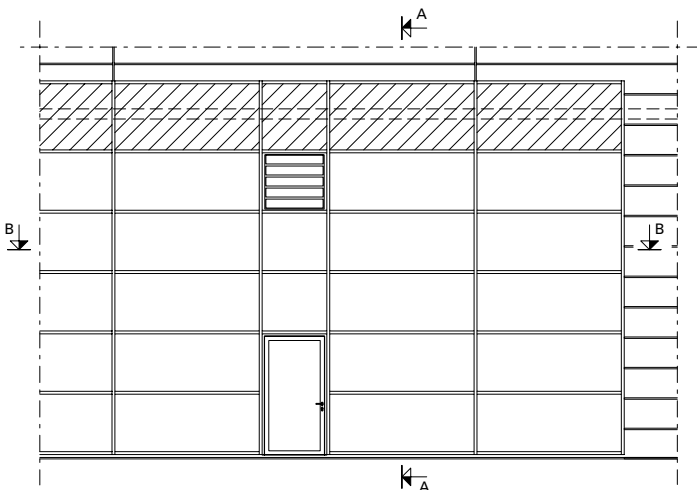
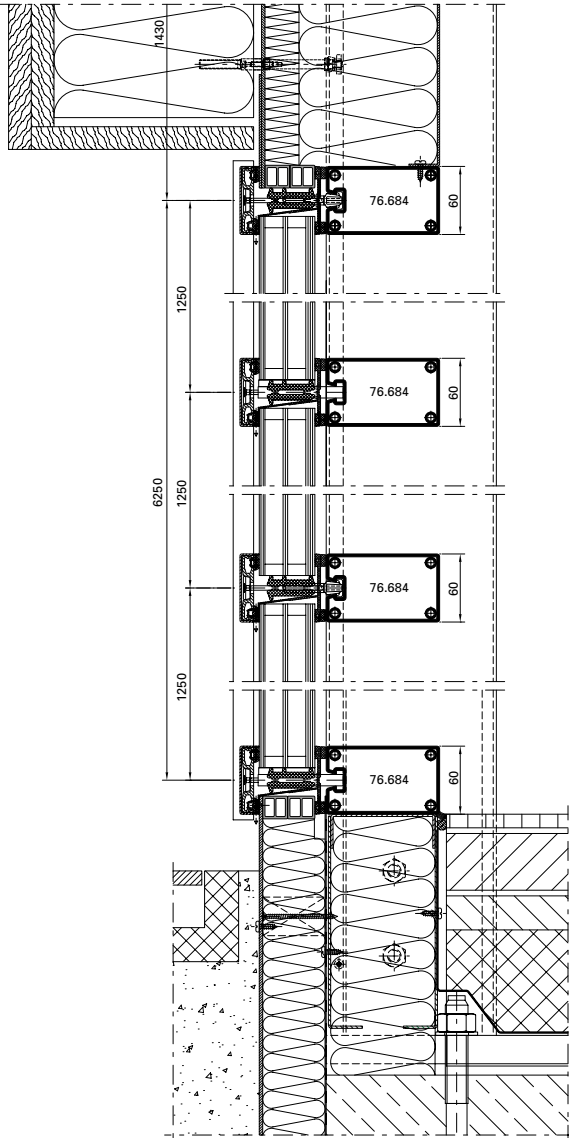

# Ausgeführte Objekte

## Objets réalisés

### Completed projects

**Objekt:**

Musikkonservatorium, Bilbao/ES

**System:**

VISS TVS

**Architekt:**

Roberto Ercilla Arquitectura,  
Vitoria/ES

**Objet:**

Conservatoire de musique, Bilbao/ES

**Système:**

VISS TVS

**Architecte:**

Roberto Ercilla Arquitectura,  
Vitoria/ES

**Project:**

Conservatory of Music, Bilbao/ES

**System:**

VISS TVS

**Architect:**

Roberto Ercilla Arquitectura,  
Vitoria/ES

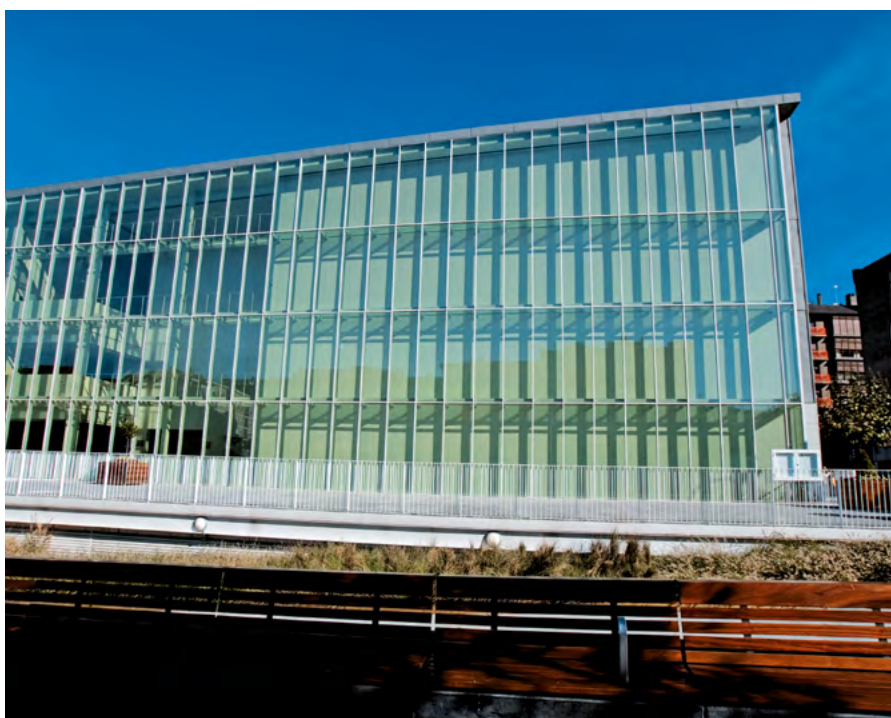
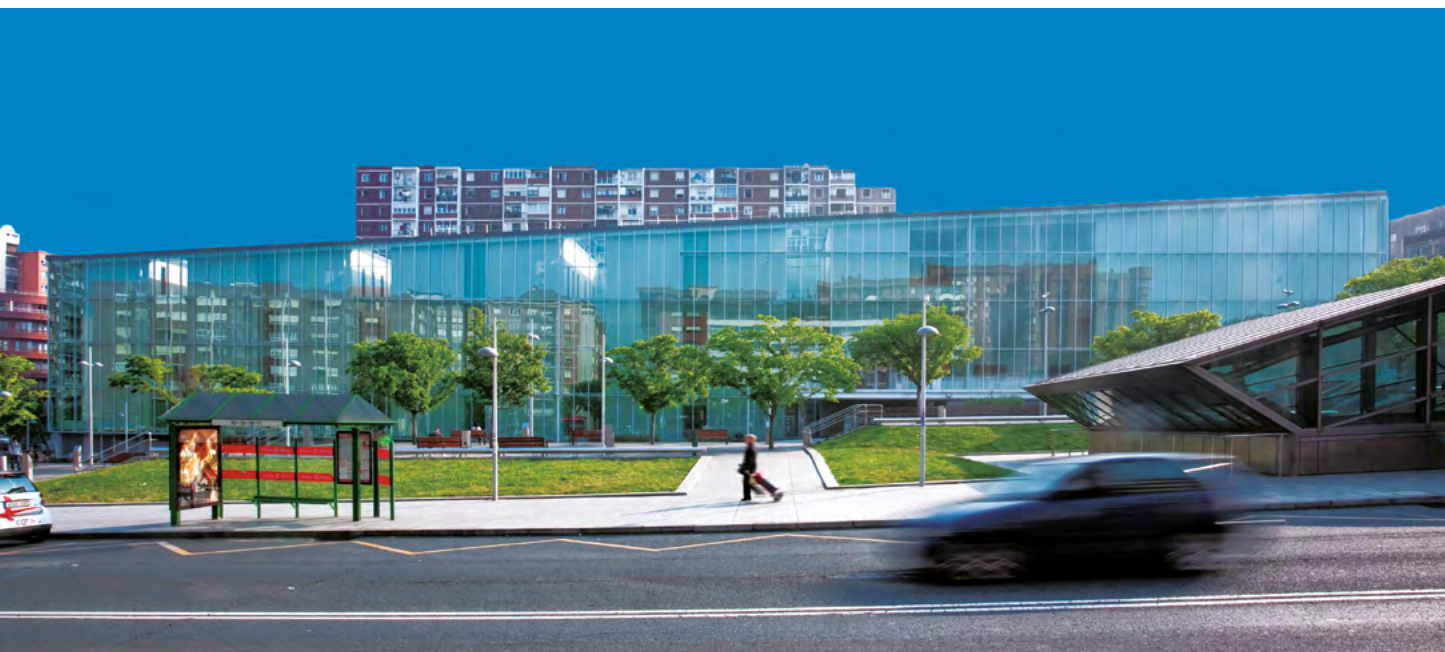

**Objekt:**

Landesberufsschule, Mureck/AT

**System:**

VISS TVS Linea

**Architekt:**

Architekten Domenig & Wallner  
ZT GmbH, Graz/AT

**Objet:**

École professionnelle, Mureck/AT

**Système:**

VISS TVS Linea

**Architecte:**

Architekten Domenig & Wallner  
ZT GmbH, Graz/AT

**Project:**

State vocational school, Mureck/AT

**System:**

VISS TVS Linea

**Architect:**

Architekten Domenig & Wallner  
ZT GmbH, Graz/AT



Ausgeführte Objekte  
Objets réalisés  
Completed projects



Fotos: Jochen Helle, Dortmund

**Objekt:**

Hafencity Schule, Hamburg/DE

**System:**

VISS Fire E30 TVS vertikal und schräg,  
Janisol Türen

**Architekt:**

Spengler-Wiescholek Architekten,  
Hamburg/DE

**Objet:**

École Hafencity, Hamburg/DE

**Système:**

VISS Fire E30 TVS vertical et oblique,  
Portes Janisol

**Architecte:**

Spengler-Wiescholek Architekten,  
Hamburg/DE

**Project:**

Hafencity school, Hamburg/DE

**System:**

VISS Fire E30 TVS vertical and sloping,  
Janisol doors

**Architect:**

Spengler-Wiescholek Architekten,  
Hamburg/DE





## A - A

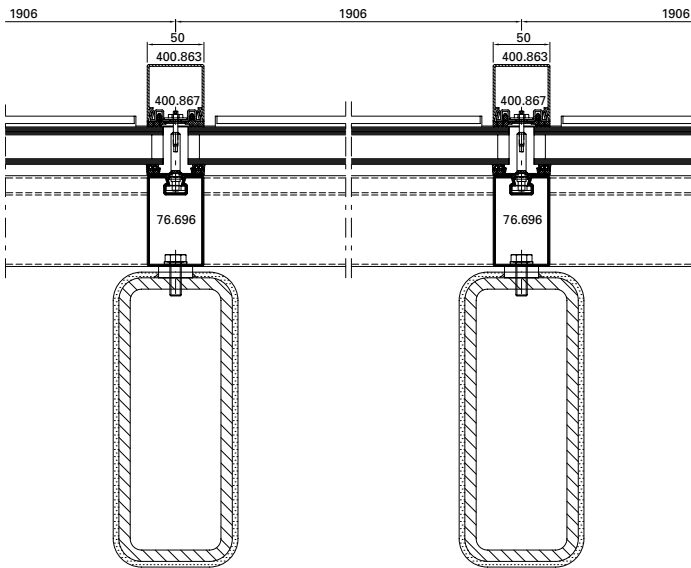

## B

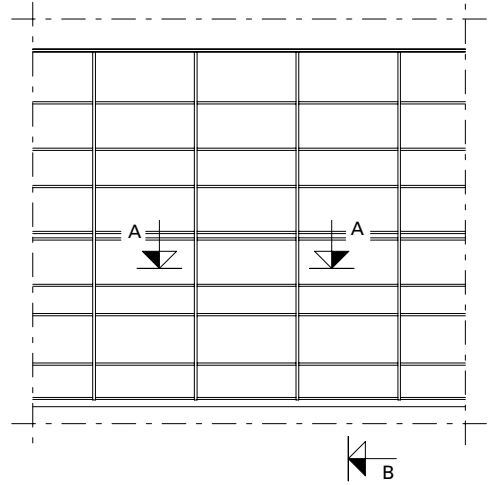

## B - B

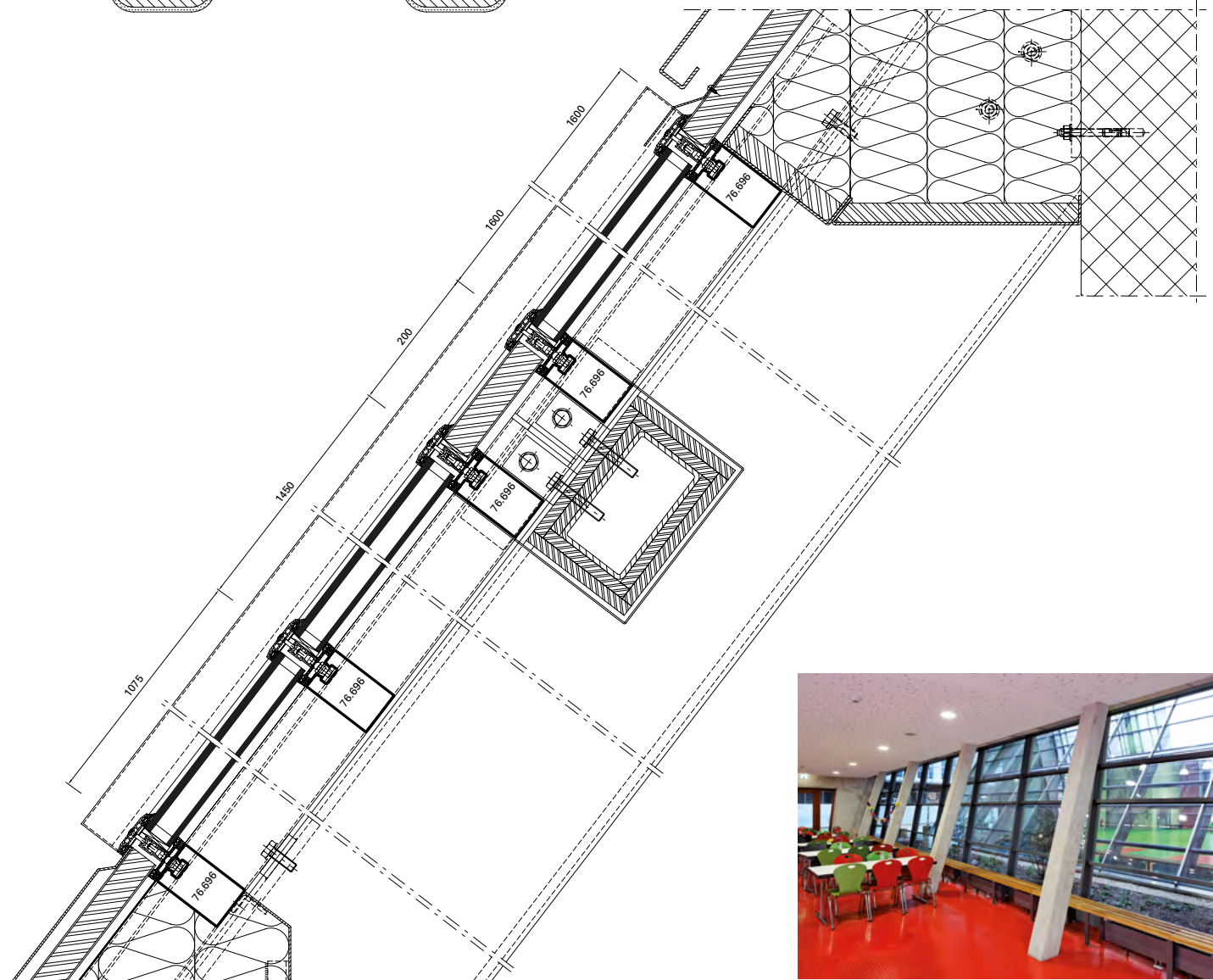

# Ausgeführte Objekte

## Objets réalisés

### Completed projects

**Objekt:**

Drehrestaurant «Hoher Kasten»,  
Brülisau/CH

**System:**

VISS Basic TVS

**Architekt:**

architekten : rlc ag, Rheineck/CH

**Objet:**

Restaurant panoramique  
«Hoher Kasten», Brülisau/CH

**Système:**

VISS Basic TVS

**Architecte:**

architekten : rlc ag, Rheineck/CH

**Project:**

Revolving restaurant «Hoher Kasten»,  
Brülisau/CH

**System:**

VISS Basic TVS

**Architect:**

architekten : rlc ag, Rheineck/CH

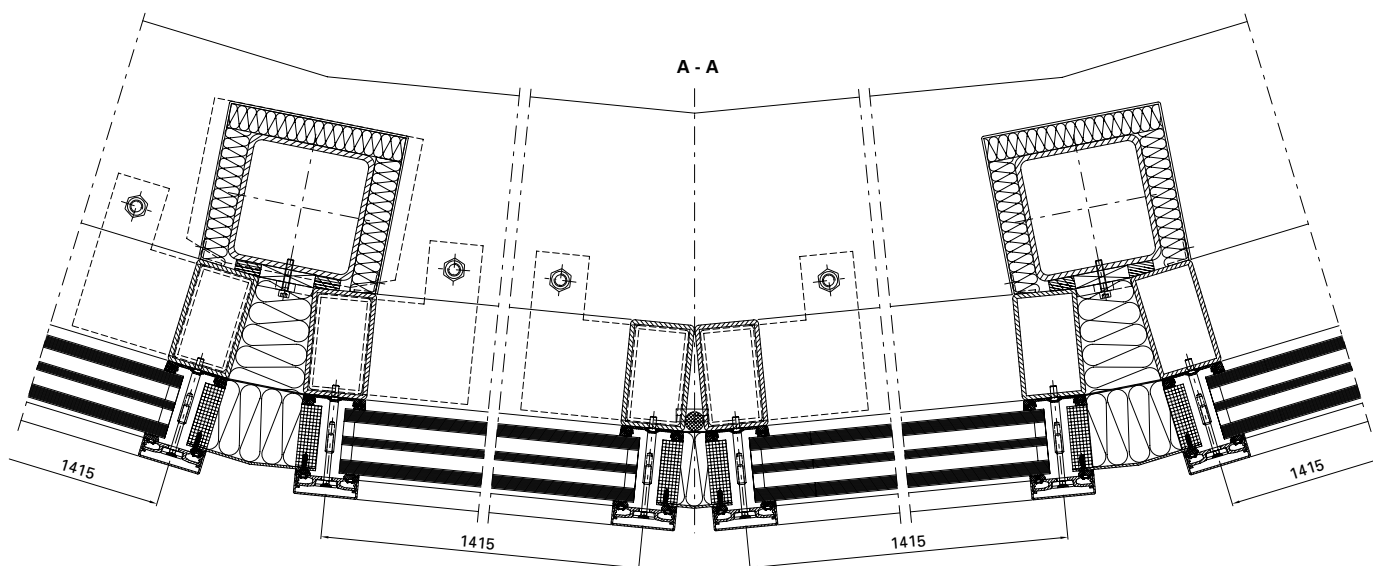

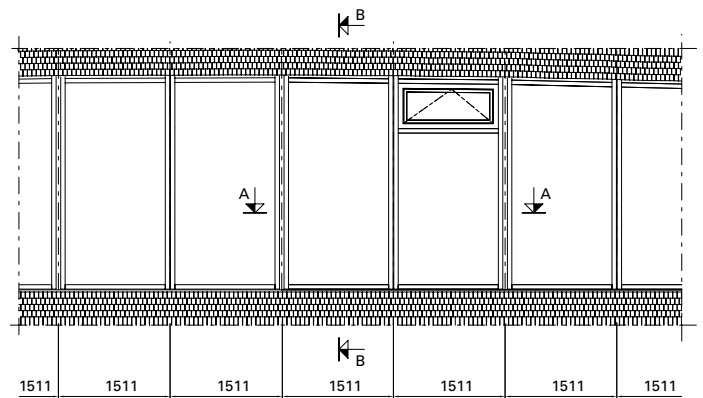
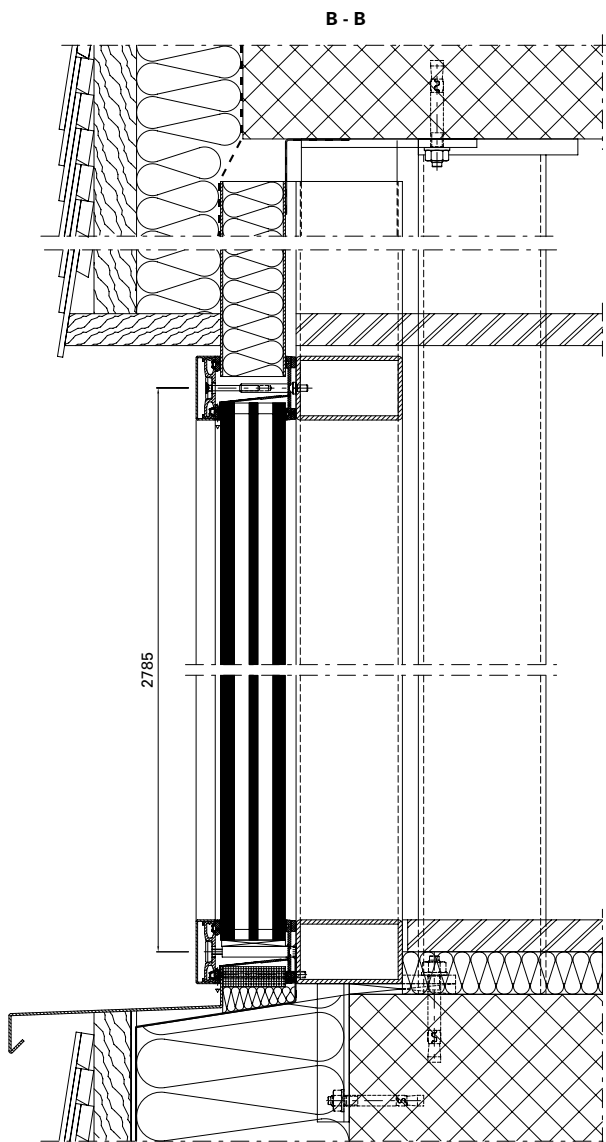

# Ausgeführte Objekte

## Objets réalisés

## Completed projects

**Objekt:**

Hauptbahnhof «Rotterdam Centraal»,  
Rotterdam/NL

**System:**

VISS Basic, VISS Fire, Janisol Türen

**Architekt:**

Team CS: Zusammenarbeit von  
Bentham Crowel Architekten,  
Meyer en Van Schooten Architecten  
und West 8, Rotterdam/NL

**Objet:**

Gare centrale «Rotterdam Centraal»,  
Rotterdam/NL

**Système:**

VISS Basic, VISS Fire, portes Janisol

**Architecte:**

Team CS: Coopération de Bentham  
Crowel Architectes, Meyer en Van  
Schooten Architectes et West 8,  
Rotterdam/NL

**Project:**

Central station «Rotterdam Centraal»,  
Rotterdam/NL

**System:**

VISS Basic, VISS Fire, Janisol doors

**Architect:**

Team CS: a cooperation of Bentham  
Crowel Architects, Meyer en Van  
Schooten Architects and West 8,  
Rotterdam/NL





# Ausgeführte Objekte

## Objets réalisés

## Completed projects

**Objekt:**

IGuzzini Illuminazione, Barcelona/ES

**System:**

VISS TVS, Janisol Fenster und Türen,  
Jansen-Economy 50/60

**Architekt:**

Josep Mias, Mias Arquitectos ACTAR,  
Barcelona/ES

**Objet:**

IGuzzini Illuminazione, Barcelone/ES

**Système:**

VISS TVS, Janisol portes et fenêtres,  
Jansen-Economy 50/60

**Architecte:**

Josep Mias, Mias Arquitectos ACTAR,  
Barcelone/ES

**Project:**

IGuzzini Illuminazione, Barcelona/ES

**System:**

VISS TVS, Janisol doors and windows,  
Jansen-Economy 50/60

**Architect:**

Josep Mias, Mias Arquitectos ACTAR,  
Barcelona/ES

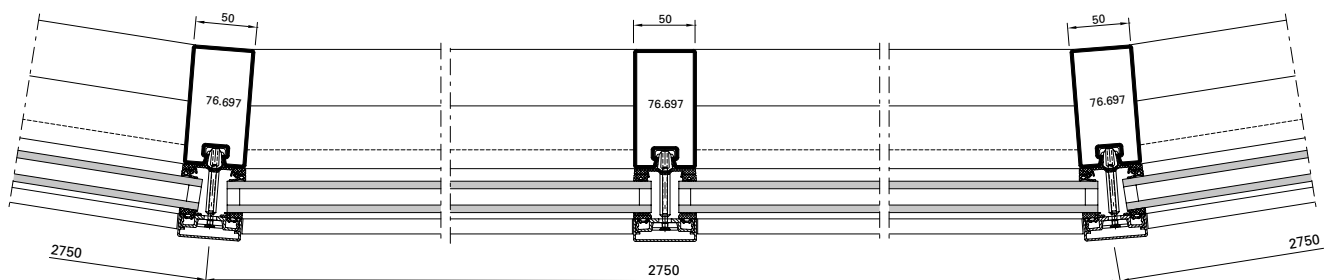

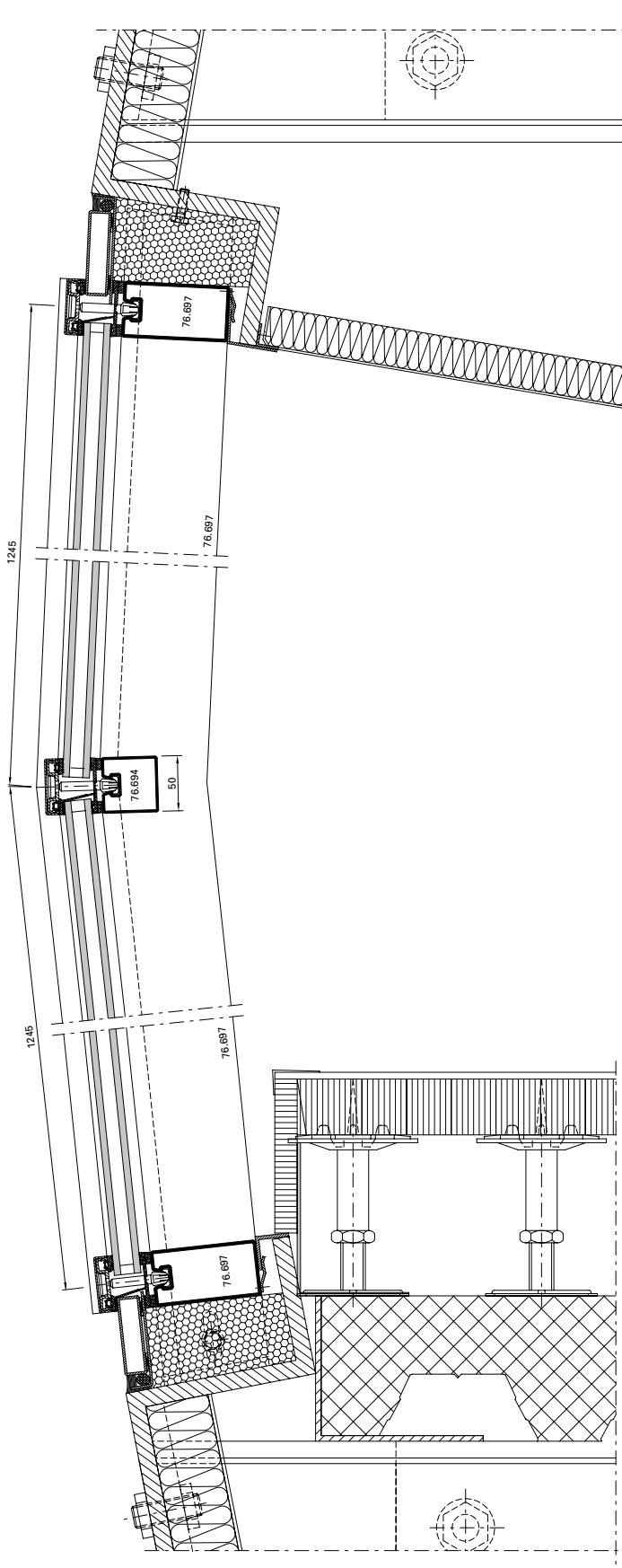

# Ausgeführte Objekte

## Objets réalisés

### Completed projects

**Objekt:**

«Erasmus» Studenten-Pavillon,  
Rotterdam/NL

**System:**

VISS I<sub>x</sub>tra SG

**Architekt:**

Powerhouse Company &  
DeZwarteHond, Rotterdam/NL

**Objet:**

Pavillon pour étudiants «Erasmus»,  
Rotterdam/NL

**Système:**

VISS I<sub>x</sub>tra SG

**Architecte:**

Powerhouse Company &  
DeZwarteHond, Rotterdam/NL

**Project:**

«Erasmus» student pavilion,  
Rotterdam/NL

**System:**

VISS I<sub>x</sub>tra SG

**Architect:**

Powerhouse Company &  
DeZwarteHond, Rotterdam/NL

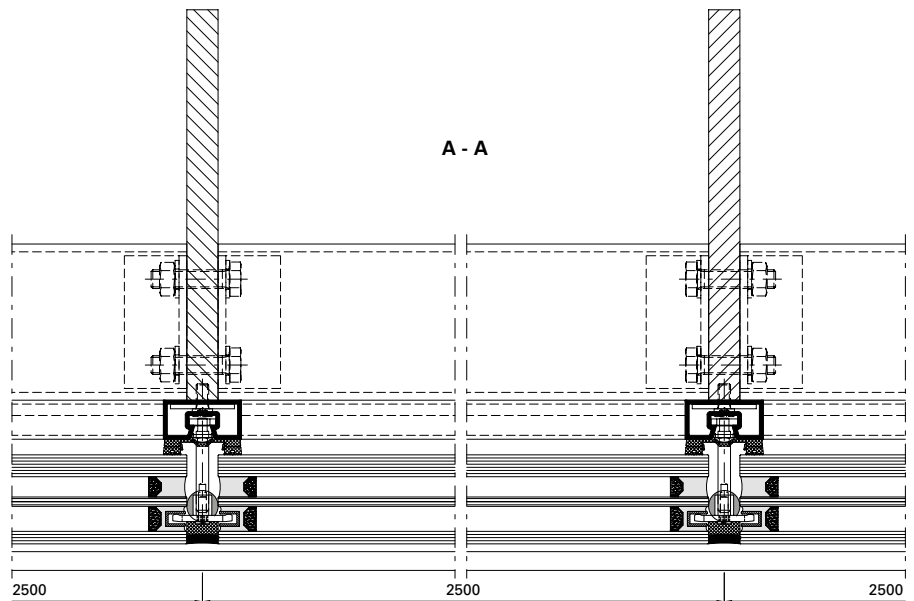



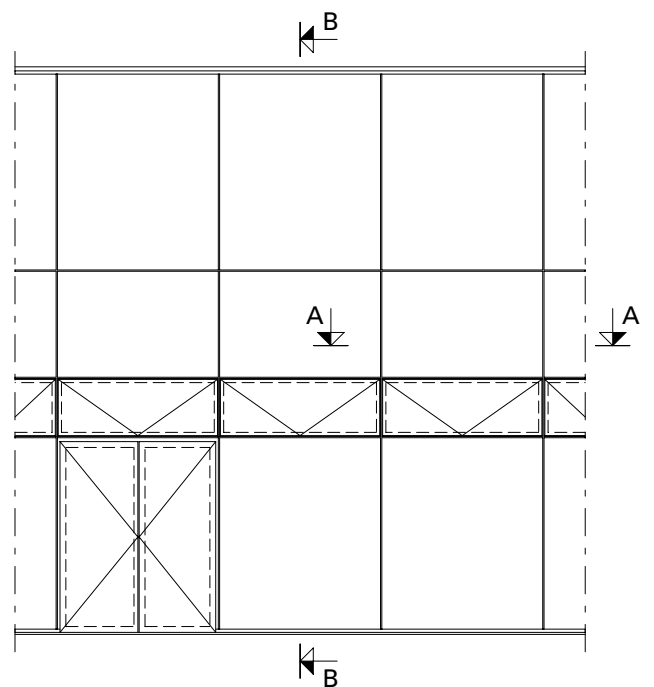
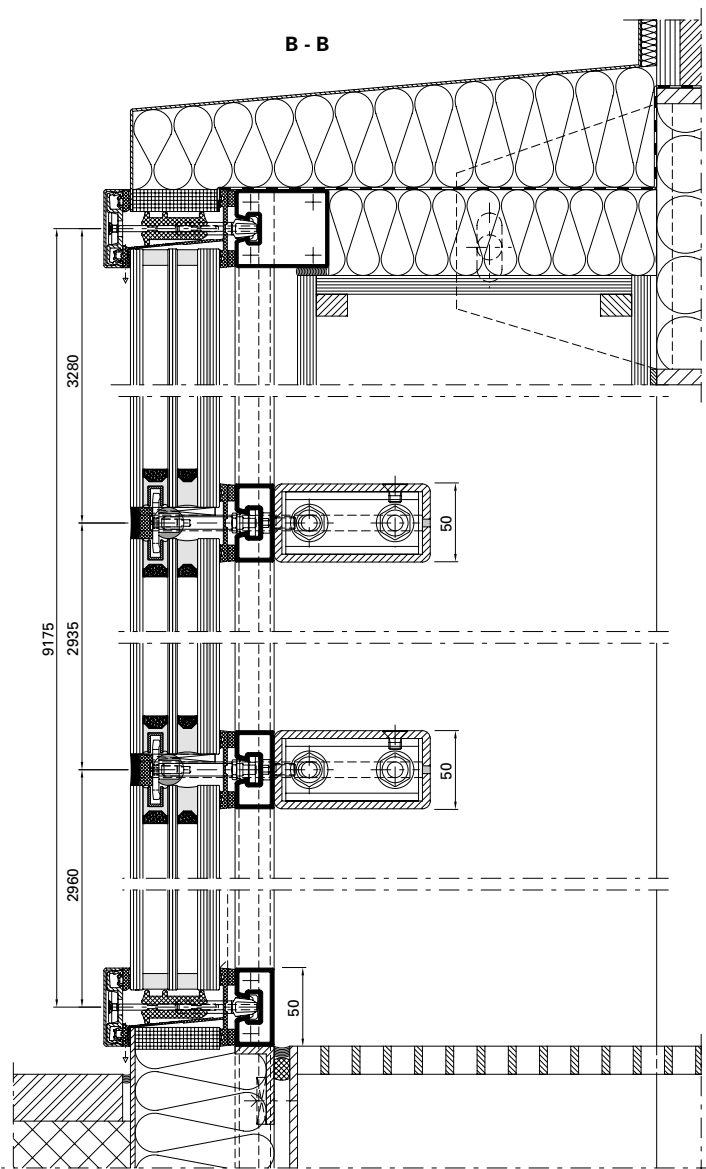
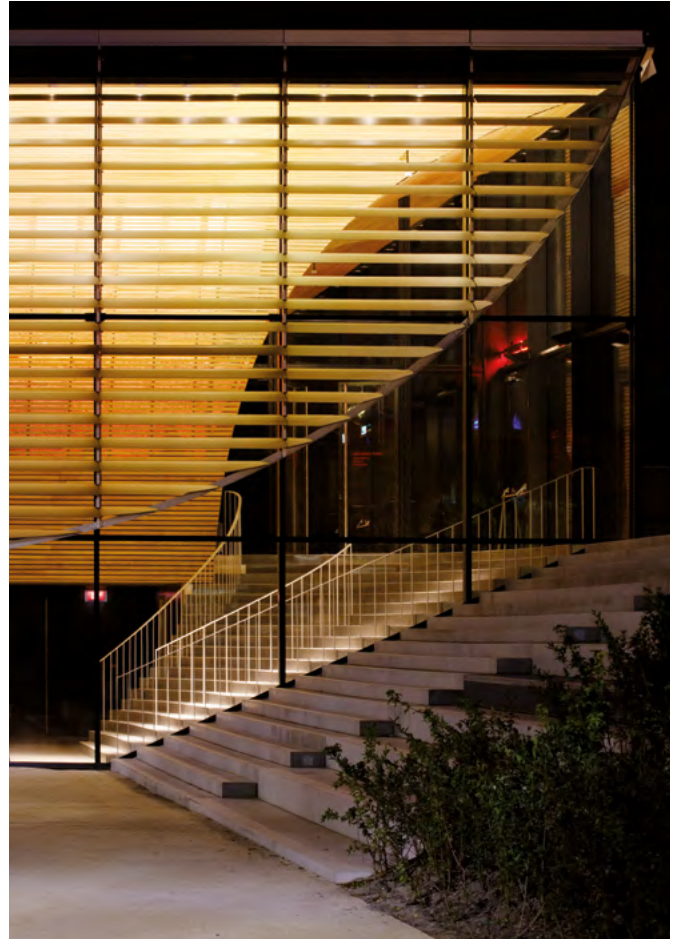

Ausgeführte Objekte  
Objets réalisés  
Completed projects



Fotos: Stephan Falk, Berlin

**Objekt:**

Hochschule «Anstalt für angewandte Wissenschaften», Dessau/DE

**System:**

VISS TVS

**Architekt:**

Kossel, Simon und Partner,  
Magdeburg/DE

**Objet:**

École supérieure «Anstalt für angewandte Wissenschaften», Dessau/DE

**Système:**

VISS TVS

**Architecte:**

Kossel, Simon und Partner,  
Magdeburg/DE

**Project:**

University «Anstalt für angewandte Wissenschaften», Dessau/DE

**System:**

VISS TVS

**Architect:**

Kossel, Simon und Partner,  
Magdeburg/DE



**Objekt:**

Justizgebäude, Würzburg/DE

**System:**

VISS TVS, VISS Fire TVS (schräg)

**Architekt:**

Staatliches Bauamt Würzburg, Abt. L4, Würzburg/DE

**Objet:**

Palais de justice, Würzburg/DE

**Système:**

VISS TVS, VISS Fire TVS (oblique)

**Architecte:**

Staatliches Bauamt Würzburg, Abt. L4, Würzburg/DE

**Project:**

Law courts, Würzburg/DE

**System:**

VISS TVS, VISS Fire TVS (sloping)

**Architect:**

Staatliches Bauamt Würzburg, Abt. L4, Würzburg/DE

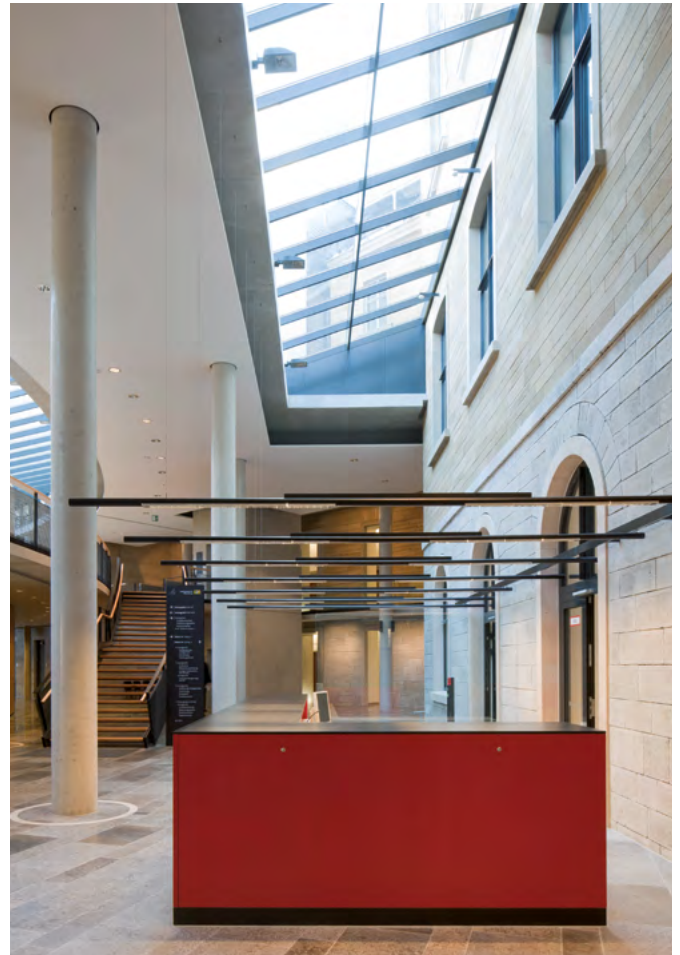

Fotos: Gerhard Hagen, Bamberg

# Ausgeführte Objekte

## Objets réalisés

### Completed projects

**Objekt:**

Halle M, Jansen AG, Oberriet/CH

**System:**

VISS TVS HI

**Architekt:**

Göldi + Eggenberger AG,  
Altstätten/CH

**Objet:**

Hall M, Jansen AG, Oberriet/CH

**Système:**

VISS TVS HI

**Architecte:**

Göldi + Eggenberger AG,  
Altstätten/CH

**Project:**

Hall M, Jansen AG, Oberriet/CH

**System:**

VISS TVS HI

**Architect:**

Göldi + Eggenberger AG,  
Altstätten/CH



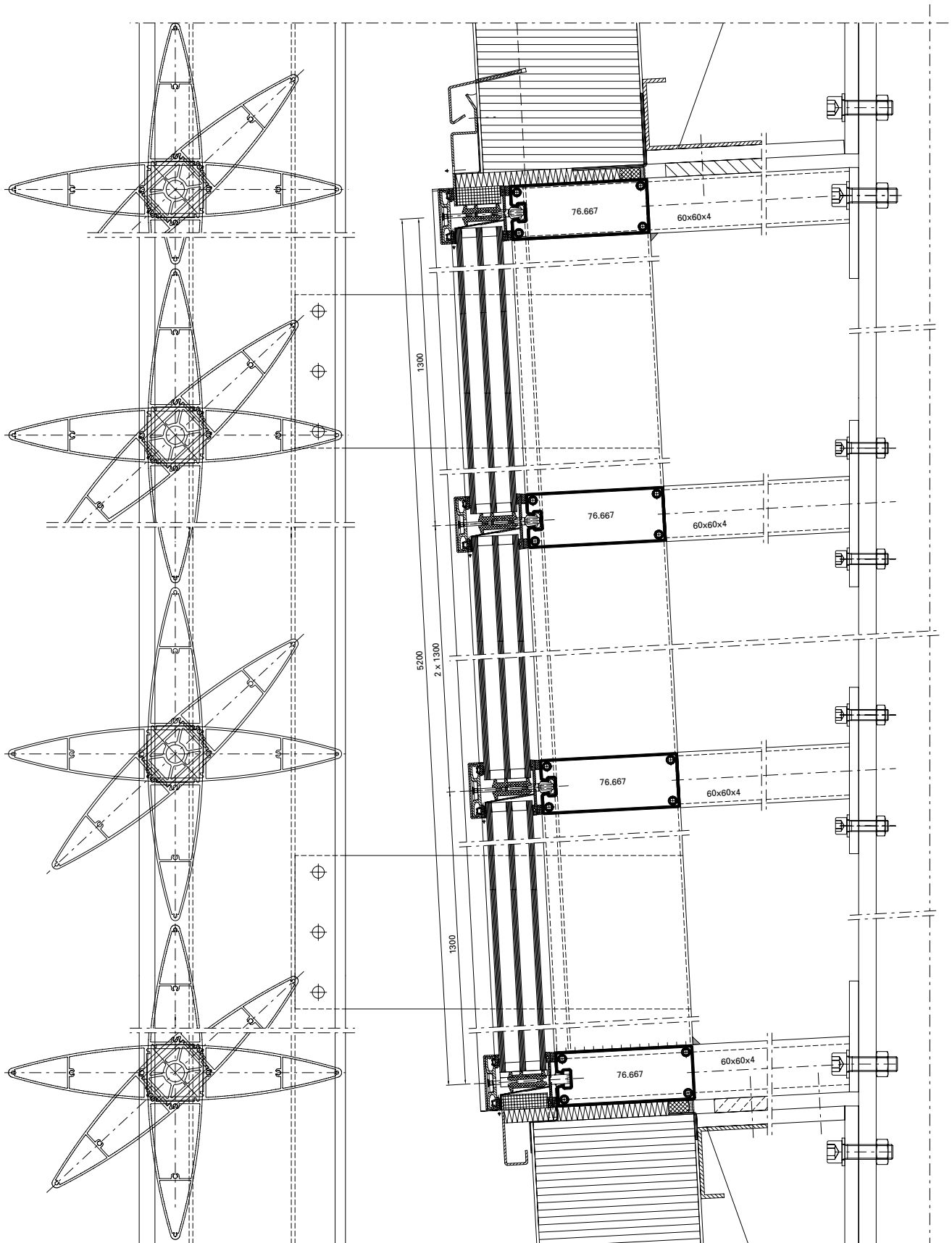

Ausgeführte Objekte  
Objets réalisés  
Completed projects



Fotos: Stephan Falk, Berlin

**Objekt:**

Vogtlandhalle (Stadthalle), Greiz/DE

**System:**

VISS TVS, Janisol Faltwand

**Architekt:**

Hoffmann.Seifert.Partner mit Ernst Scharf, Erfurt/DE

**Objet:**

Vogtlandhalle (salle municipale), Greiz/DE

**Système:**

VISS TVS, Janisol porte repliable

**Architecte:**

Hoffmann.Seifert.Partner mit Ernst Scharf, Erfurt/DE

**Project:**

Vogtland hall (city hall), Greiz/DE

**System:**

VISS TVS, Janisol folding wall

**Architect:**

Hoffmann.Seifert.Partner mit Ernst Scharf, Erfurt/DE

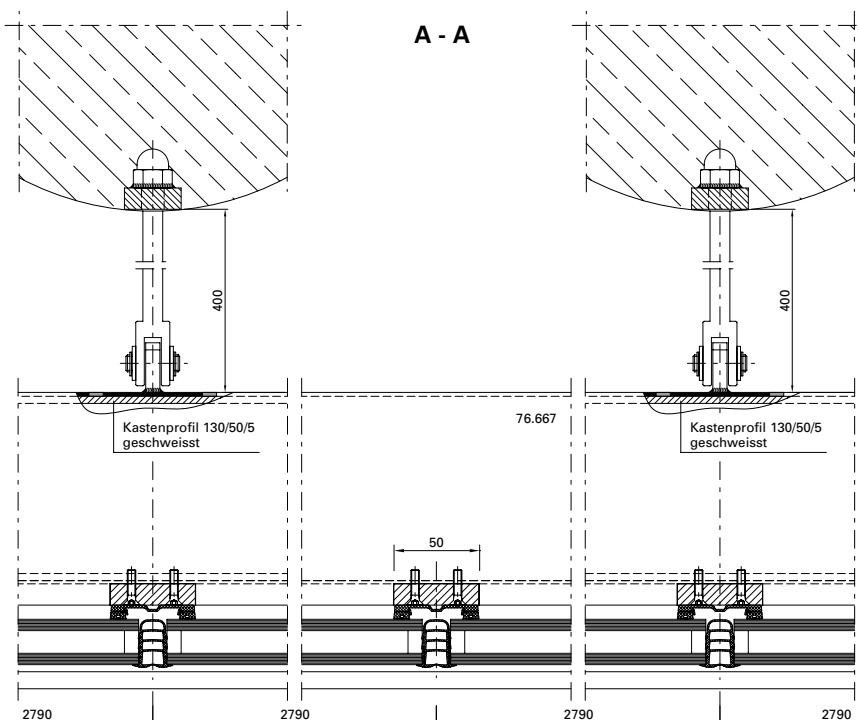

B - B

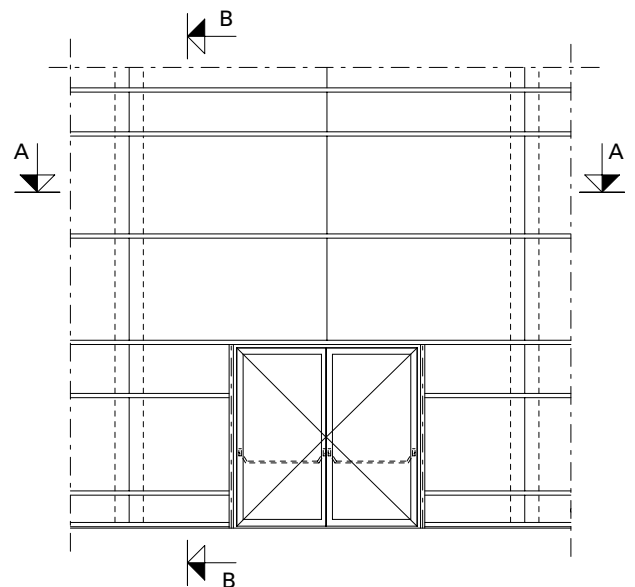
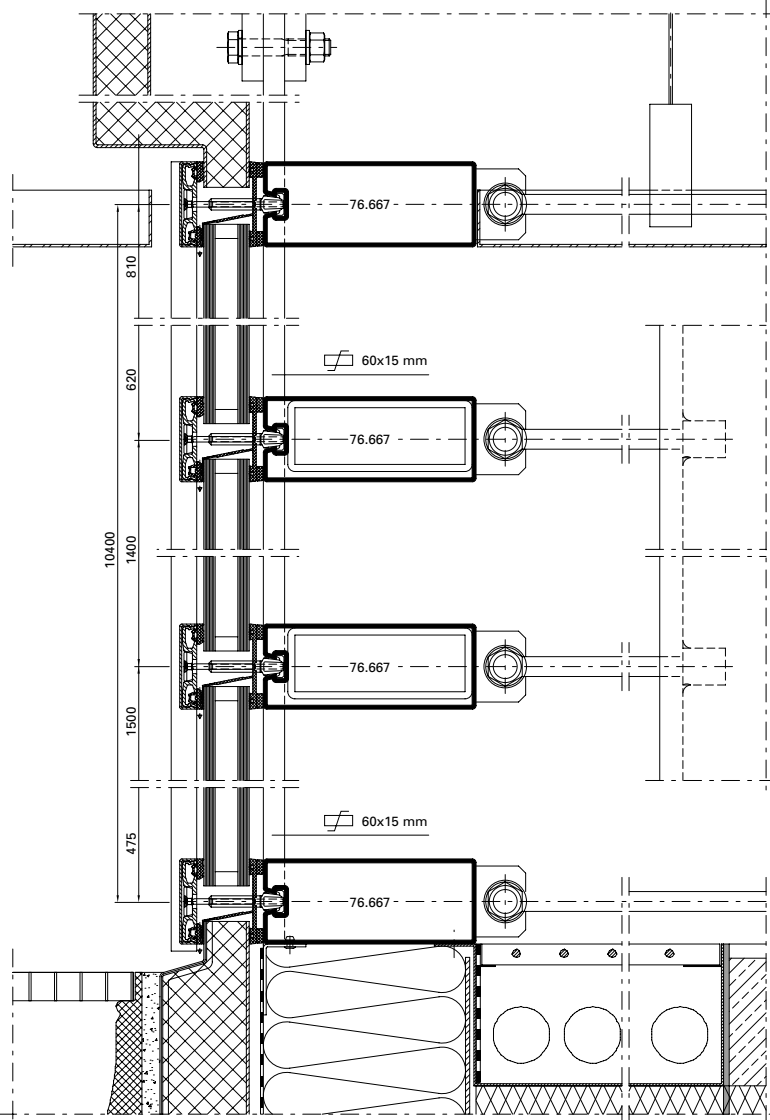

# Ausgeführte Objekte

## Objets réalisés

### Completed projects

**Objekt:**

Ausbau Messehalle BEA Expo,  
Bern/CH

**System:**

VISS Fire E30/EI30,  
Jansen-Economy E30, Janisol 2 EI30

**Architekt:**

Schwaar & Partner AG, Bern/CH

**Objet:**

Agrandissement du hall d'exposition  
BEA Expo, Berne/CH

**Système:**

VISS Fire E30/EI30,  
Jansen-Economy E30, Janisol 2 EI30

**Architecte:**

Schwaar & Partner AG, Berne/CH

**Project:**

Exhibition hall extension BEA Expo,  
Bern/CH

**System:**

VISS Fire E30/EI30,  
Jansen-Economy E30, Janisol 2 EI30

**Architect:**

Schwaar & Partner AG, Bern/CH





**Objekt:**

MAN Nutzfahrzeuge, Werkserweiterung,  
München/DE

**System:**

VISS I<sub>x</sub>tra, Janisol Türen

**Architekt:**

DMP Architekten BDA, München/DE

**Objet:**

MAN Nutzfahrzeuge, agrandissement  
de l'usine, Munich/DE

**Système:**

VISS I<sub>x</sub>tra, portes Janisol

**Architecte:**

DMP Architekten BDA, Munich/DE

**Project:**

MAN Nutzfahrzeuge, plant extension,  
Munich/DE

**System:**

VISS I<sub>x</sub>tra, Janisol doors

**Architect:**

DMP Architekten BDA, Munich/DE



# Ausgeführte Objekte

## Objets réalisés

### Completed projects

**Objekt:**

Museumsquartier, Den Bosch/NL

**System:**

VISS I<sub>x</sub>tra TV

**Architekt:**

Bierman Henket Architecten, Esch/NL

**Objet:**

Quartier des musées, Den Bosch/NL

**Système:**

VISS I<sub>x</sub>tra TV

**Architecte:**

Bierman Henket Architecten, Esch/NL

**Project:**

Museum Quarter, Den Bosch/NL

**System:**

VISS I<sub>x</sub>tra TV

**Architect:**

Bierman Henket Architecten, Esch/NL



B - B

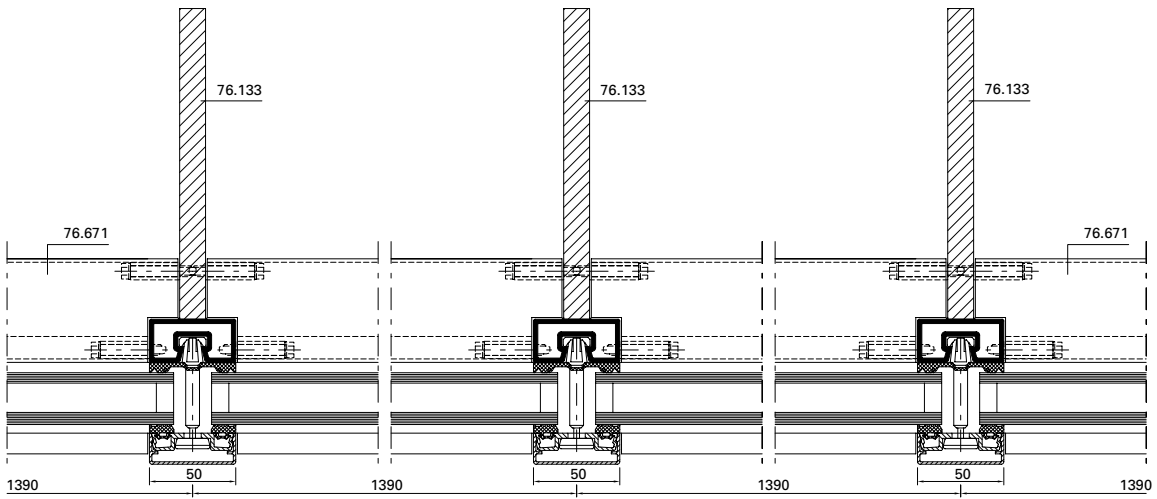

A - A

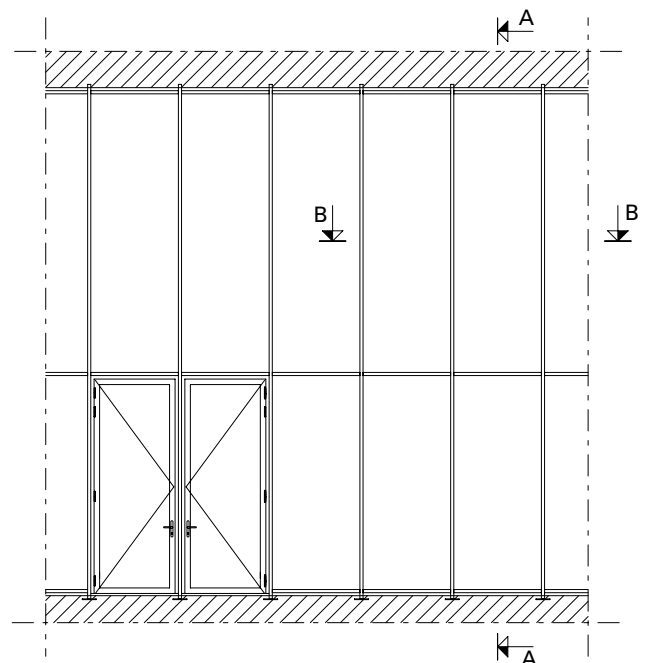
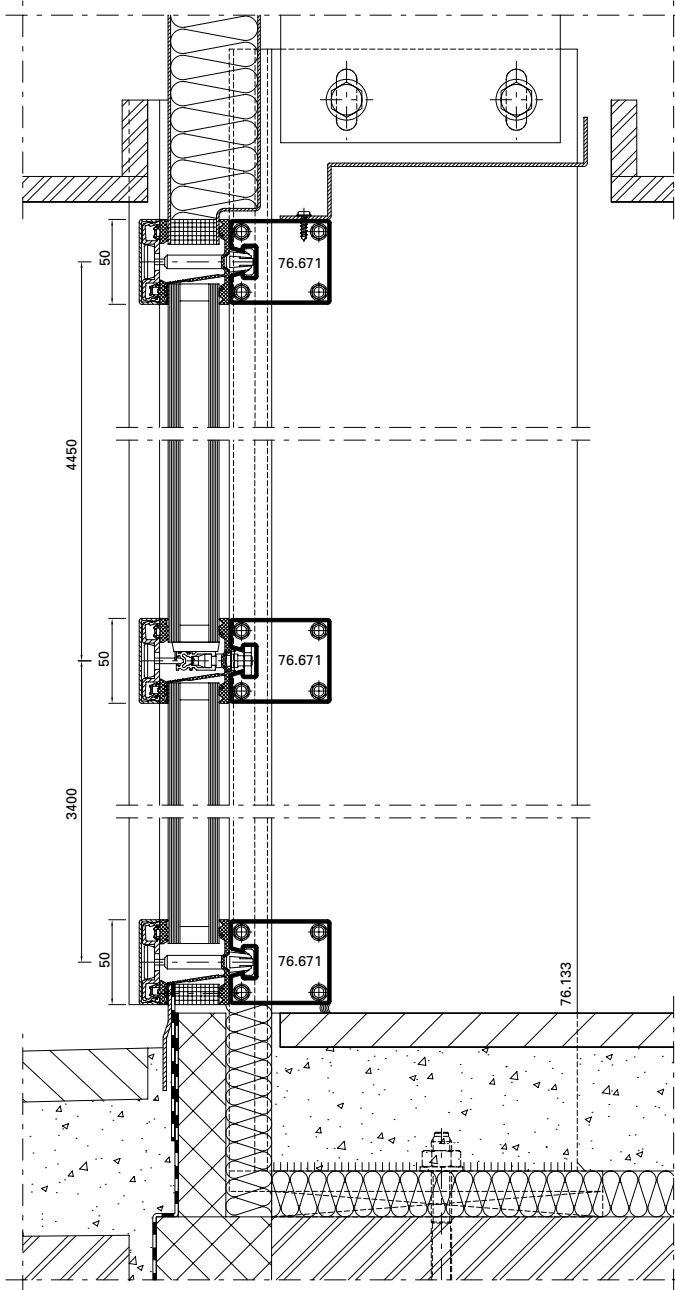

# Ausgeführte Objekte Objets réalisés Completed projects

**Objekt:**

Werkhalle Glas Trösch,  
St.Gallen/CH

**System:**

VISS TVS

**Architekt:**

Schuchter Ehle, Architekten, St.Gallen/  
CH

**Objet:**

Atelier de Glas Trösch,  
Saint-Gall/CH

**Système:**

VISS TVS

**Architecte:**

Schuchter Ehle, Architekten,  
Saint-Gall/CH

**Project:**

Glas Trösch factory building,  
St. Gallen/CH

**System:**

VISS TVS

**Architect:**

Schuchter Ehle, Architekten, St.Gallen/  
CH





**Objekt:**

Voentorg Center,  
Moskau/RU

**System:**

VISS TV, VISS Fire

**Architekt:**

Mosprojekt-2: Kolosnitsin Vladimir  
Vasilyevich / Starikov Alexander  
Fedorovich, Moskau/RU

**Objet:**

Centre Voentorg,  
Moscou/RU

**Système:**

VISS TV, VISS Fire

**Architecte:**

Mosprojekt-2: Kolosnitsin Vladimir  
Vasilyevich / Starikov Alexander  
Fedorovich, Moscou/RU

**Project:**

Voentorg Center,  
Moscow/RU

**System:**

VISS TV, VISS Fire

**Architect:**

Mosprojekt-2: Kolosnitsin Vladimir  
Vasilyevich / Starikov Alexander  
Fedorovich, Moscow/RU



# Ausgeführte Objekte Objets réalisés Completed projects

**Objekt:**

Neue Messehalle  
(Kielce Trade Fairs), Kielce/PL

**System:**

VISS TVS (vertikal und schräg),  
Janisol 2 E130, Falttore

**Architekt:**

bsp Architekten: Barbara Średniawa,  
Gliwice/PL

**Objet:**

Nouveau hall d'exposition  
(Kielce Trade Fairs), Kielce/PL

**Système:**

VISS TVS (vertical et oblique),  
Janisol 2 E130, Porte accordéon

**Architecte:**

bsp Architekten: Barbara Średniawa,  
Gliwice/PL

**Project:**

New exhibition hall  
(Kielce Trade Fairs), Kielce/PL

**System:**

VISS TVS (vertical and sloping),  
Janisol 2 E130, Folding doors

**Architect:**

bsp Architekten: Barbara Średniawa,  
Gliwice/PL



